

ATTO 3

OWNER'S MANUAL



BYD

bydauto.co.nz

Foreword

Thank you for choosing BYD ATTO 3. To better use and maintain your BYD ATTO 3, please read this manual carefully and keep it properly after reading.

Special Instructions: BYD recommends that you choose genuine spare parts and use, maintain, and repair the vehicle properly in accordance with this manual. The use of non-genuine spare parts to replace or modify the vehicle will affect the performance of the entire vehicle, especially its safety and durability. Vehicle damage and performance issues caused by use of non-genuine spare parts will not be covered by the warranty. In addition, modifications to vehicles may also violate national laws and regulations and local government regulations.

Thank you again for choosing BYD ATTO 3, and your valuable comments and suggestions are welcome. To enjoy better services, please provide your accurate contact information. If there is any change to the information, contact a BYD authorized dealer or service provider to update the information in the system. You are also advised to pay attention to the relevant national laws and regulations and local policies, and register the vehicle as soon as possible; otherwise vehicle registration may fail.

Pay attention to the "REMINDER", "CAUTION" and "WARNING" symbols in this manual, and follow the instructions carefully to avoid injury or damage. These symbols are defined as follows:



REMINDER: Items that must be observed to facilitate maintenance, etc.



CAUTION: Items that must be observed to avoid damage to the vehicle.



WARNING: Items that must be observed to ensure personal safety.



is a safety mark that indicates an operation that should not be performed or an event that should not happen.

- * The descriptions marked with the asterisk (*) in this manual are specific to only some model configurations, and applicable only when the vehicle has these configurations. The picture used is taken from one of these configurations. If there is any difference with the vehicle you purchased, refer to the actual vehicle.

This manual is expected to help you use the product correctly, and does not provide any description of the configuration and software version of this product. For details about the product configuration and software version, please refer to the contract (if any) related to this product, or consult the seller who sold the product to you.

Copyright © BYD Auto Co., Ltd. All rights reserved.

No part of this document may be reproduced or transmitted in any form or by any means without prior written consent of BYD Auto Co., Ltd.

All rights reserved

Contacting Us

If you require assistance or clarification on policies or procedures, please contact the customer relationship center.

E-mail: bydauto@ateco.co.nz

Model Overview

BYD ATTO 3 is a new energy, new power, and pure electric passenger car. It is the kind of environmentally sustainable product that BYD is dedicated to making. It features a load-bearing body, front-to-rear longitudinal beam, and power battery pack integrated with the body to fully ensure the safety of the battery and entire vehicle.

BYD ATTO 3 is driven by electric motors in various working conditions, and therefore can achieve zero emissions.

Being a pure electric vehicle, the BYD ATTO 3 features very low levels of internal and external noise, providing an exceptional driving and riding experience unmatched by any internal combustion vehicle.

The safety of the high-voltage system has been a priority in this vehicle's design, so that driver and passenger safety is ensured in case of a collision.

This vehicle is equipped with a battery management unit that continually monitors its power battery, adjusts power output based on various performance indicators such as voltage and current of each battery cell, and prevents issues affecting battery performance, such as over-charge, over-discharge, and overheating, thus permanently ensuring the battery works under ideal conditions.

The 150 kW motor provides the ATTO 3 with high speed, high torque, and powerful start-up acceleration ability.

ILLUSTRATION INDEX

Exterior	10
Dashboard Panel	11
Center Console	12
Door	13

SAFETY

Seat Belts	16
Introduction to Seat Belts.....	16
Using Seat Belts.....	16
Airbag System	19
Introduction to Airbags.....	19
Driver and Front Passenger Airbags.....	19
Front Seat Side Airbags.....	20
Side Curtain Airbags.....	21
Airbag Triggering Conditions and Notes.....	21
Child Restraint System (CRS)	25
Child Restraint System (CRS).....	25
Anti-Theft System	31
Anti-Theft System.....	31
Data Collection and Processing	32
Data Collection and Processing.....	32

DASHBOARD

Instrument Cluster	36
Instrument Cluster View.....	36
Instrument Cluster Indicators	37

CONTROLLER OPERATIONS

Car Doors and Keys	48
Introduction to Keys.....	48
Locking/Unlocking Door.....	50
Smart Access and Start System	57

Child Protection Lock.....	58
Seats	59
Seat Information	59
Front Seat Adjustment	60
Folding in Rear Seats.....	61
Head Supports.....	61
Steering Wheel	62
Switches	65
Light Switches.....	65
Wiper Switches.....	69
Front Door Switches	71
Odometer Toggle Switch	73
Driver Assistance Switch Group.....	73
Window Control Switch on Passenger Side	73
Emergency Warning Light Button	74
Mode Switch Group	74
PAB Switch*	75
Sunroof Switch	76
Interior Light Switches	77

USING AND DRIVING

Charging/Discharging	80
Charging Instructions	80
Charging Methods.....	84
Discharging Equipment*	88
Charging Port Electric Lock Control Function.....	90
Driving Range Display.....	90
Energy Regeneration Settings.....	91
Batteries	91
Power Battery	91
Low Voltage Battery (12 V)	94
Usage Essentials	95
Break-In Period.....	95
Towing Practices	95

Driving Safety Precautions	95
Suggestions for Vehicle Use	96
How to Save Energy and Prolong Vehicle Service Life	97
Carrying Luggage	97
Flood Precautions.....	98
Fire Prevention	99
Starting and Driving	101
Starting the Vehicle	101
Driving.....	102
Gear Shift Controls.....	102
Electric Parking Brake (EPB).....	103
Automatic Vehicle Hold (AVH).....	105
Driving Key Notes	107
Driving Assistance Functions	108
ACC System*	108
Predictive Emergency Braking System ...	112
Traffic Sign Recognition System*	114
Lane Keeping System*	115
Intelligent Cruise Control System*	116
Blind Spot Detection System*	118
Tire Pressure Monitoring.....	120
Panoramic View System*	122
Parking Assistance System	123
Driving Safety Systems	126
Acoustic Vehicle Alerting System (AVAS).....	130
0-100 km/h: Full Throttle Experience.....	131
Instructions for Other Main Functions.....	131
Rear View Mirror	131
Electronic Side Mirrors	132
Wipers	133
Vehicle Travelling Data Recorder*	134

IN-CAR DEVICES

Air Conditioning System

A/C Panel View	138
A/C Operation Interface	138
Function Definitions	141
Vents.....	143
Air Purification System*	144
Switching on A/C with Cloud Service APP	145

Storage

Door Bins	146
Glove Box.....	146
Center Console Cubby.....	146
File Pockets	146
Cup Holder	147

Other Devices.....

Sun Visors.....	147
Safety Handle	147
USB Ports.....	148
12 V Auxiliary Power Outlet.....	148
Mobile Phone Wireless Charging Location.....	148
Luggage Compartment Cover*	150

Infotainment System

Infotainment Control Panel PAD.....	151
Widgets	152
Language Setting	152

MAINTENANCE

Maintenance Information

Maintenance Cycle and Contents.....	154
Regular Maintenance.....	159
Regular Maintenance.....	159
Vehicle Corrosion Prevention.....	160

Paint Maintenance Tips.....	160
Vehicle Cleaning.....	161
Interior Cleaning.....	162
Self-Maintenance	163
Self-Maintenance	163
Sunroof Maintenance	165
Vehicle Storage	166
Hood.....	167
Cooling System.....	167
Braking System.....	168
Windshield Washer	168
Air Conditioning System	169
Wiper Blades	169
Tires.....	170
Fuses	172

WHEN FAULTS OCCUR

When Faults Occur.....	182
If Smart Key Battery is Exhausted.....	182
Emergency Shutdown System	182
Vehicle Fire Rescue	183
Battery Leakage Rescue	183
If the Vehicle Needs Towing	184
In Case of a Flat Tire.....	185
When the Battery Runs Out	187
When the Vehicle Needs Supporting	188

VEHICLE SPECIFICATIONS

Data Information.....	190
Vehicle Parameters	190
Vehicle Identification.....	193
Tips	194
Warning Labels.....	194
Transponder Mounting Position.....	196

01

ILLUSTRATION INDEX

Exterior	10
Dashboard Panel	11
Center Console.....	12
Door	13

Exterior

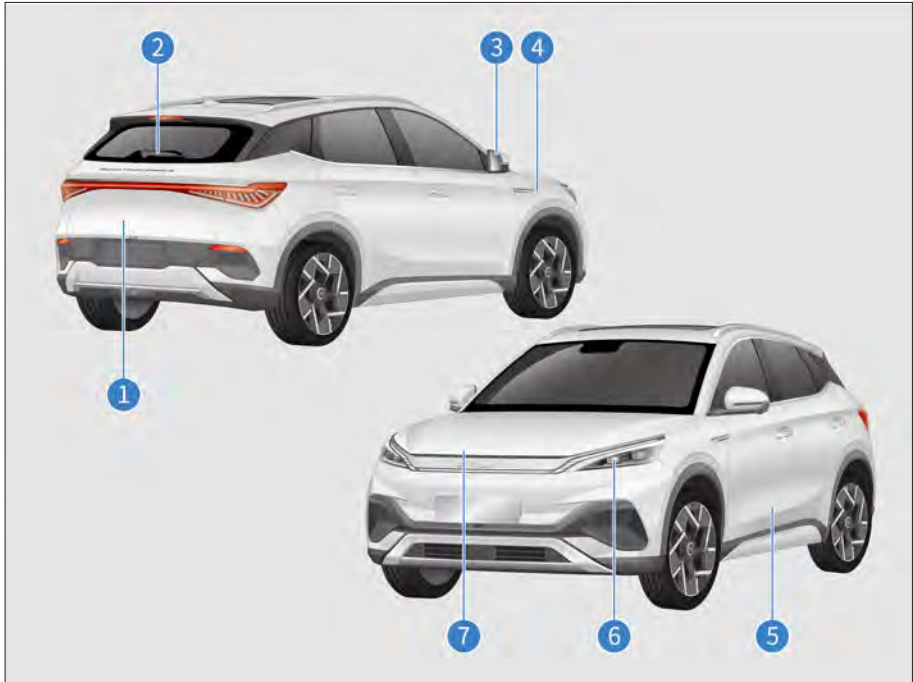

1 Trunk Lock **P54**

Trunk **P97**

Tools Delivered with the Vehicle **P185**

2 Rear Wiper **P133**

3 Side Mirror **P132**

4 Home Portable AC Charging **P84**

AC Charging Pile Charging **P86**

Charging Station DC Charging **P87**

External Discharge **P89**

5 Door **P50**

6 Combination Light **P165**

7 Opening the Hood **P167**

Refrigerant **P167**

Brake Fluid **P168**

Under Hood Power Distribution Box (PDB) **P173**

Dashboard Panel

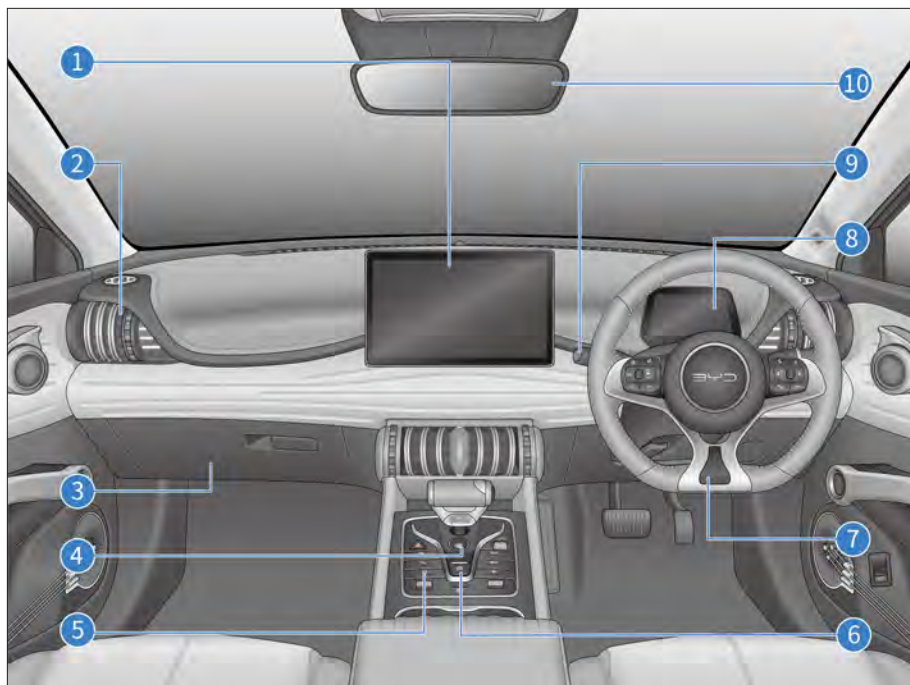

- | | | | |
|---|--|----|--|
| 1 | Infotainment Control Panel P151
A/C Settings Interface P138
A/C Function Definitions P141 | 6 | EPB Switch P103 |
| 2 | A/C Vents P143 | 7 | Steering Wheel Adjustment P65
Steering Wheel Switch Group P62 |
| 3 | Glove Box P146 | 8 | Instrument Cluster P36 |
| 4 | Start/Stop Button P101 | 9 | Front Windshield Wipers and Washer P69
Rear Windshield Wiper and Washer P70 |
| 5 | AVH Switch P103 | 10 | Rear View Mirror P131 |

Center Console

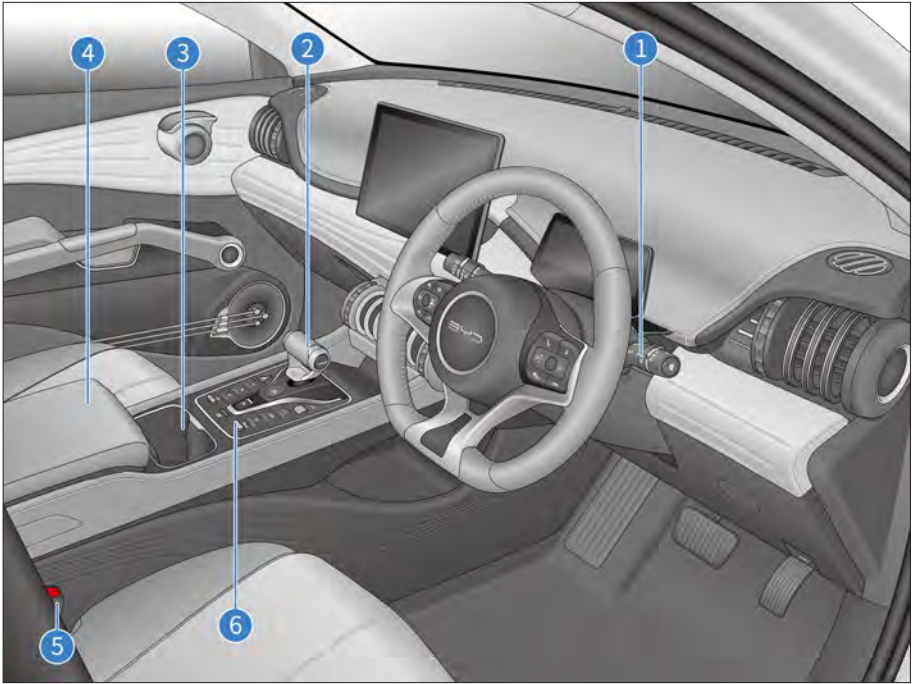

1 Light Adjustment Switch **P65**

2 Gearshift Lever **P102**

3 Cup Holder **P147**

4 Center Console Cubby **P146**

5 Seatbelt Lock **P16**

6 Mode Switch Group **P74**

Door

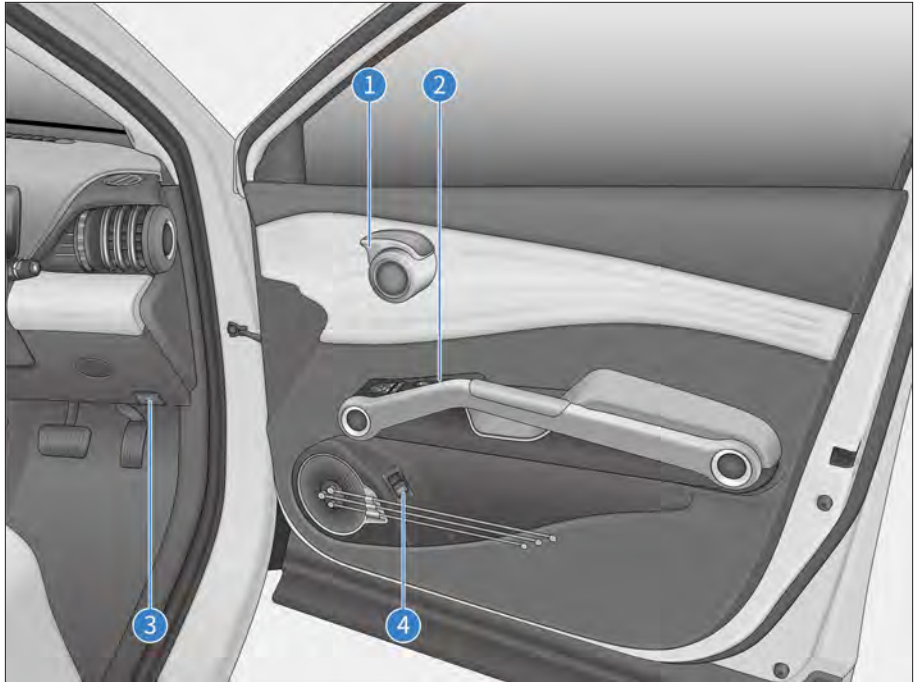

- | | | | |
|---|--|---|-------------------------|
| 1 | Opening Car Door with Interior Door Handle P51 | 3 | Hood Handle P167 |
| 2 | Electric Window Switches P71
Window Lock Button P72
Center Console Door Lock P72
Side Mirror P132 | 4 | Trunk Lock P54 |

02

SAFETY

Seat Belts.....	16
Airbag System	19
Child Restraint System (CRS)	25
Anti-Theft System	31
Data Collection and Processing.....	32

Seat Belts

Introduction to Seat Belts

Studies have shown that proper use of seat belts can significantly reduce casualties in emergency braking, sudden steering, or collisions. Please read the following information carefully and observe it strictly.

CAUTION!

- Always have the seatbelt fastened while the vehicle is in motion.
 - Before driving, make sure all occupants have their seat belts properly fastened to prevent serious injury.
 - Vehicle seat belts are designed for adults, not being suitable for children. Make sure the appropriate CRS is chosen according to children's age and size (refer to the **CRS** section).
 - If a seat belt is damaged or malfunctions, contact a BYD authorized dealer or service provider for confirmation and handling. Until then, please do not use the corresponding seat.
- It's mandatory for all vehicle occupants to fasten their seat belts at all times. Failure to do so increases the risk of injury in case of an accident.
 - Children must sit in the rear seat and must fasten seat belts for protection. Accident statistics indicate that a child who sits in the rear seat and properly uses a child restraint device is much safer than a child sitting in the front seat.
 - Do not allow children to travel standing or kneeling on the rear seat, nor sitting on someone's lap, for there is a high risk of serious injury in case of emergency braking or collision.

Seat Belt Emergency Locking Retractor (ELR) Function

- When the driver turns sharply, brakes suddenly, when there is a collision, or when the occupant leans forward too quickly, the seat belt automatically locks to effectively restrain and protect the occupant.
- Occupants can move freely when the vehicle is running smoothly and the seat belts are pulled out or retracted slowly.
- If the seat belt locks due to sudden retraction, let it retract a little further and slowly pull it back.

Seat Belt Pretensioner and Force Limiter Function*

When there is a serious frontal collision and the triggering conditions of the pretensioner and force limiter are met, the pretensioner quickly retracts part of the seat belt to enhance protection. The force limiter buffers the seat belt's restraint force on the occupant's body within a certain range, to prevent injury from excessive restraint force.

Using Seat Belts

1. Adjust the seat position and backrest angle. (See **Front Seat Electronic Adjustment**)
2. Adjust the position of the three-point seat belt.

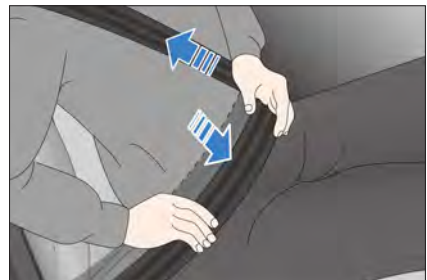

- Keeping a proper sitting posture, pull the seat belt out so that it is diagonally across the chest. The belt should not go under the arm or across the back of the neck.
 - Keep the belt lap part as close as possible to the hips.
3. Insert the latch plate into the buckle until a "click" is heard, then pull it back to make sure it is firmly locked. Do not fasten the belt if it twisted.



4. The height of the front seat belts can be adjusted for optimum comfort and protection.

- Press the release button and move the adjuster up or down to the intended position. Release the button to lock the adjuster. Pull the belt firmly to check that it is locked.

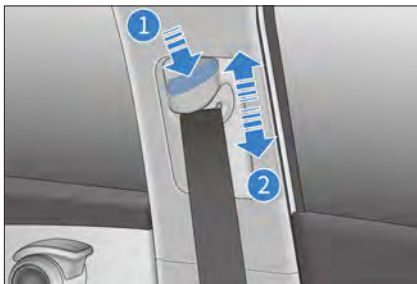

! REMINDER

- In order to ensure the seat belt provides due protection and prevents injury, the belt should cross over the middle of the occupant's shoulder, be kept away from the neck, and not easily slip off.
- The lap belt should be as low across the hips as possible, to avoid the seat belt tightening on the abdomen and injuring the passenger in the event of an accident.
- For proper protection, the seat belt must be in permanent contact with the occupant's body.

5. Unlocking the seat belt

- Press the red unlock button on the buckle. The latch plate pops out, and the seat belt automatically retracts.
- If the seat belt does not retract smoothly and automatically, pull it out and check whether it is twisted.



! CAUTION!

- Each seat belt must be used by only one person at a time. Please do not share one seat belt between two or more passengers, not even if they are children.
- Avoid traveling with the backrest leaning too far back. The more upright the backrest, the better the protection.

CAUTION!

- In order to prevent damage, do not let any part of the seat belt get caught in the door or back seat.
- Check all the vehicle's seat belts for chafing, wearing out, loosening or any other issues. If any problem is found, contact a BYD authorized dealer or service provider for confirmation and handling. Until then, do not use the corresponding seat.
- Do not remove, disassemble or modify the seat belts without permission.
- After an accident, have the seat belts checked at a BYD authorized dealer or service provider. If the preloading function is activated, the seat belt must be replaced.
- In the event of a serious accident, even if there is no apparent damage, the seat belt should be replaced along with the seat assembly. The airbag system should also be thoroughly inspected.
- Pregnant women should also fasten their seat belt with the correct method just as other passengers. Particularly, be sure to position the lap belt portion of the seat belt as low across the hips as possible, to prevent serious injury.
- The back seat belts' fastening method is the same as the front's. For proper protection, make sure the latch is inserted in its corresponding buckle. It is the driver's responsibility to remind passengers to fasten seat belts properly.
- In order to prevent damage, do not insert any foreign object into the buckle.

Unfastened Seat Belt Reminder Function

If any vehicle occupant fails to fasten their seat belt after the vehicle is started, a visual and sound alarm will go off until the corresponding seat belt has been properly fastened.

- Unfastened seat belt indicator
 - If any seat belt remains unfastened, the unfastened seat belt indicator will flash.
- Display of the unfastened seat belt position
 - The indicator displays the corresponding position of the unfastened seat belt.
- Unfastened Seat Belt Reminder for Passengers
 - If any seat belt is unfastened after the vehicle is started ("OK" on cluster), the indicator displays both detection and position of the unfastened seat belt. If the seat belt remains unfastened after the vehicle starts moving, a warning will sound to remind the occupants.

REMINDER

- If any fault is found, contact a BYD authorized dealer or service provider for confirmation and handling. Until function is restored to normal, do not use the corresponding seat.
- It is imperative that all vehicle occupants have their seat belts fastened when the vehicle is in motion, otherwise they will be under serious risk of injury or even casualty in case of an accident.

Airbag System

Introduction to Airbags

- The airbag system is a part of the auxiliary restraint system, and also a supplement to the seat and seat belt. When the vehicle is involved in a serious collision and conditions are met, the airbag deploys and provides head protection along with the seat belt chest protection.
- Airbags are divided into front and side types, according to the type of collision. Front airbags include both driver and front passenger airbags, and side airbags include front seat side and side curtain airbags.
- As an integral part of the vehicle's passive safety protection system, the airbag system does not replace seat belts, and it must be combined with the use of seat belts to maximize protection.

MCB (Multi-Collision Brake) Function

- If an accident requires front airbags activation, the vehicle will engage automatic braking.
- Speed reduction, along with intervention by additional driving systems (Electronic Stability Control (ESC), Anti-lock Braking System (ABS)), will assist the vehicle to maintain stability and lane position.
- Hazard and brake lights will also light up to alert oncoming traffic and prevent further collisions.
- To support emergency service rescue and vehicle recovery, brakes will release and brake lights will go off after the accident.
- The driver can interrupt the multi-collision braking at any time by accelerating or braking.

CAUTION!

- Occupants must sit in a proper position to maximize the protection provided by the seat belt and the airbag system.
- Do not disassemble or assemble the airbag components without authorization.
- The use of seat covers other than BYD original products may result in poor airbag performance and consequential injury. Do not place anything between the side airbag and the passenger.
- Do not apply excessive force to the side of seats equipped with side airbags.
- After a collision, even if the airbag module did not deploy, and the pretensioner did not lock the seat belt, the airbag computer may be encrypted in order to protect the passengers from the dangers of high voltage. Contact a BYD authorized dealer or service provider to carry out testing.

Driver and Front Passenger Airbags

This vehicle is equipped with driver and front passenger airbags. When the airbag system Electronic Control Unit (ECU) detects a moderate to severe front impact, and the triggering conditions are met, the airbags deploy.



Front Airbag Deployment

- In moderate to severe frontal crashes, a sensor detects a sharp deceleration and sends a signal to the ECU to trigger the front airbags.
- When there is a frontal crash, the seat belt secures the occupant's lower body and torso in place. The airbag cushions and protects the occupant's head and chest.
- When the severity of the impact does not reach the airbag deployment threshold, the seatbelt provides enough protection.
- The front airbag deflates immediately after inflation, without affecting the driver's vision and ability to operate the steering wheel or other controls.
- The airbag deploys within a thousandth of a second.
- A loud noise is heard when the airbag deploys. It does not cause injury, but it may cause tinnitus or temporary deafness.
- A cloud of dust from the airbag surface may come off when the airbag deploys. Although such powder is non-toxic, individuals with respiratory problem might experience some temporary discomfort.
- The front passenger airbag is controlled by the PAB switch. For details, see **PAB Switch***

Front Seat Side Airbags

The vehicle is equipped with side airbags for the left and right front seats (installed in the outer edges of the front seat backrests and marked with "AIRBAG", as shown):

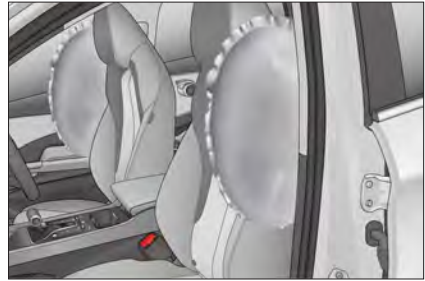

- When the ECU detects a moderate to severe side impact, and the triggering conditions are met, the side airbag deploys to protect the occupant's chest.
- When a side impact occurs, generally only the airbag on the impacted side deploys.
- If the impact occurs on the passenger side, the airbag on the passenger side deploys even if there is no passenger in the seat.
- For optimum side airbag protection, the occupant must have their seat belt fastened and be sitting in an upright position.

Front Center Airbag:

- The vehicle is equipped with front center airbag (installed in the inner edge of the driver seat and marked "AIRBAG", as shown):



- When the ECU detects a moderate to severe front or side impact, and the triggering conditions are met, the front center airbag deploys to protect the heads and shoulders of the driver and the front passenger.
- If the impact occurs on the front passenger side, the front center airbag deploys even if there is no passenger in the seat.
- For optimum front center airbag protection, the occupant must have their seat belt fastened and be sitting in an upright position.

In a vehicle equipped with seat side airbags:

- Do not let the backrests get wet. If they get wet from rain or splashes, the side airbag system may not work properly.
- Users are not to cover or replace the backrest covers by themselves. Unsuitable backrest covers may prevent airbag deployment.

Side Curtain Airbags

- The vehicle is equipped with left and right side curtain airbags (installed at the junction of the body side trim and the ceiling and marked with "Curtain AIRBAG" on the A-pillar trim, B-pillar trim, and C-pillar trim, as shown):



- when the ECU detects a moderate to severe impact and the triggering conditions are met, the curtain airbag deploys to protect the occupant's head.

- When a side impact occurs, generally only the airbag on the impacted side deploys.
- For optimum curtain airbag protection, the occupant must have their seat belt fastened and be sitting in an upright position.

Airbag Triggering Conditions and Notes

Cases When Airbags May Be Deployed

The vehicle's nose hits the ground when crossing a deep groove.



The vehicle hits a bump or curbstone.



The vehicle's nose hits the ground when going down a steep slope.



The vehicle goes under a truck or other large vehicle.



One side of the vehicle is hit by another vehicle.



The tail of the vehicle is hit by another vehicle.



Cases Where Airbags May Not Be Deployed

The vehicle hits a concrete pillar, tree, or similar object.



The vehicle rolls over.



The vehicle hits a wall or another vehicle diagonally.



Parts other than the passenger compartment receive side impacts.



The lateral side of the vehicle is hit diagonally.



The lateral side of the vehicle hits a columnar object.



⚠ WARNING!

- Airbags are developed to match specific car models. Any changes to suspension, tire sizes, bumpers, chassis and original equipment can adversely affect the airbag system. Users must not use any parts of the airbag system on other car models; doing so may lead to failure of the airbag system.
- Drivers should maintain a distance of at least 25 cm between their chest and the steering wheel, in order for the system to provide the most effective driver protection.
- Fasten your seat belt and sit properly while the vehicle is in motion. If the seat belt is not fastened, if the occupant is leaning forward or sitting improperly, airbag deployment can increase the risk of injury.
- Do not paste stickers, cover or decorate the hub cover of the steering wheel, the right side surface of the dashboard panel or the surface of A, B and C pillar trims. Clean these surfaces with a dry or damp cloth, without applying too much pressure.

WARNING!

- A child is not to be seated in the front passenger seat, nor are they to ride sitting on a front passenger's lap, to prevent serious injury or even casualty caused by airbag deployment.
- No accessories, like phone or cup holders or ashtrays, must be installed on airbag covers or within their action range.
- Side curtain airbags are triggered by strong impacts at high speeds, so occupants must not lean against the doors of vehicles equipped with this type of airbag while these vehicles are in motion.
- Do not place any other gadgets or items within the action range of the side curtain airbags, such as the windshield, side door glass, A-pillar trim, ceiling, B-pillar trim, C-pillar trim and auxiliary handle. When the side curtain airbag is triggered, the gadget or item may be thrown with the impact force from the side air curtain, or the side air curtain may not be deployed normally.
- When transferring car ownership, make sure to pass on all of the vehicle's documents.
- Do not disassemble or repair the A-pillar trim, ceiling, B-pillar trim or C-pillar trim, which contain side curtain airbags. These changes can cause system failure or accidental triggering of curtain airbags.
- Do not change any component of the airbag system, including any corresponding label. Any operation done to the airbags must be performed by a BYD authorized dealer or service provider.

WARNING!

- Airbags can only provide one-time accident protection. Once an airbag is triggered or damaged, the airbag system must be replaced.
- When scrapping the car or disposing of parts of the airbag system, observe the related safety regulations and disposal procedures.
- The airbag system has strong anti-interference and anti-disturbance resistance to electromagnetic fields around it. However, do not use the vehicle in electromagnetic environments above state approved ranges.
- This vehicle's airbag system has been developed by considering a series of road condition factors, however, drivers are advised to drive carefully in rough terrains in order to avoid impacts to the bottom of the vehicle.
- This vehicle's airbag system has been fully verified to seamlessly match the vehicle's original wiring harness system. Any wiring harness alteration may cause the airbags to deploy without proper triggering or fail to deploy in the event of a collision.

If any of the following events occurs, contact a BYD authorized dealer or service provider immediately.

- The airbags have deployed.
- The airbag warning light  on the instrument cluster lights up abnormally.
- The airbag system is monitored by the ECU and has a self-diagnostic function. The airbag warning light can be checked on the instrument cluster to determine the airbag system status.

- When the vehicle power status is on "OK", if the airbag warning light keeps on for about 5 s and goes off and keeps off for more than 5 s, the system is normal.
- If the airbags are disabled, the warning light is constantly on, and the airbags cannot provide protection.

If any of the following occurs, the airbag system is faulty:

- The ignition switch is on "OK" but the warning light goes off.
- The ignition switch is on "OK" but the warning light does not go off 5 seconds, or goes off and then on again.
- The ignition switch is on "OFF" but the warning light goes on.
- The warning light goes on, or flashes while driving. If a fault occurs, go to a BYD authorized dealer or service provider for inspection and repair as soon as possible.
- There is a collision with the front of the vehicle (highlighted area shown), but the front airbags do not deploy.



- The airbag cover is broken, cracked, or damaged in any way.

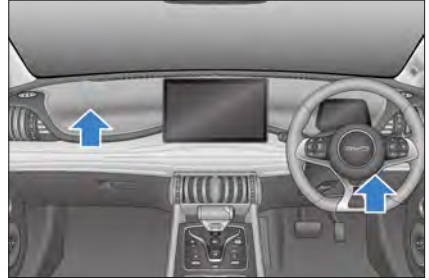

- Airbags need to be disassembled, installed, or repaired.

Child Restraint System (CRS)

Child Restraint System (CRS)

Select a suitable child restraint system for your child's weight and stature.

- Select an appropriate CRS for your child. Children who are too big to use a CRS, should sit in the rear seat and use seat belt.

When CRS is not used

- Properly secure the CRS on the seat. Do not place the CRS on the passenger seat or in the trunk without securing it.

CAUTION!

- Do not allow occupants to carry babies or infants on their laps.
- Children must always ride in appropriate child restraint devices.
- To ensure children are safely seated, follow all instructions provided in this document and the child restraint system manufacturer.

REMINDER

- BYD Auto recommends that children should use an appropriate child restraint system, and it is recommended that they are seated on a rear outboard seat.
- Always follow the detailed instructions provided by the child restraint system manufacturer.
- Make sure the child restraint system is tightly fastened.
- Secure the top straps when installing the CRS.

Installing ISOFIX/i-Size Child Restraint Systems

Rear outboard seating position

- The rear outboard seats are equipped with ISOFIX/i-Size anchorages.
- The anchorage locations are identified by a marking (see illustration) located on the seat back, directly above the associated anchorages.



- The rear seats are equipped with tether strap anchorages on the back of the seat.



Installing the CRS

Identify the appropriate anchorages and install the child restraint system.

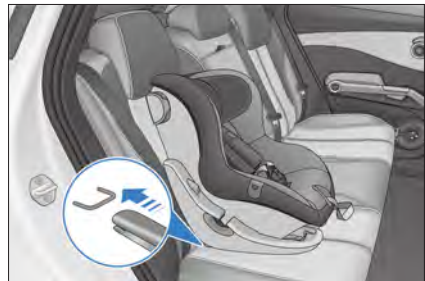

CAUTION!

- The anchorages are located in the gap between the seat cushion and the seat backrest.

When any CRS is installed, except for a booster seat without a back, it is advised that the adjustable vehicle head restraint is removed, and stowed safely.



When a booster seat without a back is installed, the adjustable vehicle head restraint must remain fitted, and adjusted to the appropriate height for the seated child.

When the seat position does not have any CRS or booster seat installed, the adjustable vehicle head restraint must remain fitted, and adjusted to the appropriate height for the occupant.

Attach the tether strap to the anchorage, then tighten the top tether as per the instructions provided by the manufacturer of the child seat.

Make sure that the tether strap is attached securely.

(1) Top straps

(2) Anchorage

CAUTION!

- Before installing the child seat top tether, remove the trunk luggage compartment cover.
- If a headrest is removed, make sure to store it safely in the luggage compartment.
- BYD recommends installing the CRS using the ISOFIX anchorage points of the car.

- If the driver seat obstructs or interferes with the correct installation of the child restraint system, on the rear outboard seat behind the driver, install the child restraint system on the other rear outboard seat.

Child restraint installed on front passenger seat

- When using a rear-facing child seat, turn the PAB switch to OFF to disable the front passenger seat airbag.
- For details, see **PAB Switch***
- Identify the appropriate anchorages and install the child restraint system.



- The rear outboard seats are equipped with ISOFIX/i-Size anchorages. The anchorage locations are identified by a marking (see illustration) located on the seat back, directly above the associated anchorages.

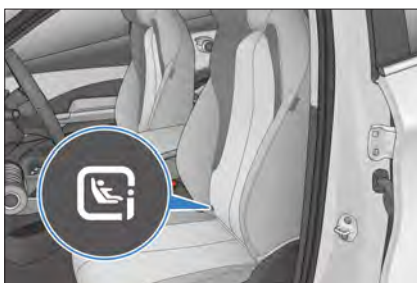

- The front passenger seat is equipped with a tether strap anchorage on the back of the seat.

! WARNING!

- Never use a rear-facing child seat on the front passenger seat with the airbag activated.
- Front-facing passengers (children or adults) must never sit on the front passenger seat with the passenger airbag deactivated.
- When a forward facing child restraint system is used on the front passenger seat, make sure the seat is positioned fully rearward away from the active airbag.
- Before seating a child, ensure the child restraint system is securely installed and does not rotate or move away from the seat.
- When using a child restraint system always ensure: the anchorages are not obstructed; the seat belt is in the correct position; and the child restraint system is securely installed.
- Failure to follow the advice given, or to follow the instructions from the child restraint system manufacturer, can endanger life or lead to serious personal injury.

! CAUTION!

- Extension straps may be required to connect the top tether to the anchorage, if the top tether length is insufficient.
- When installing a size class R3 child restraint system, ensure the seat is fully rearward before the installation.

- Where applicable to use a top tether strap with the child restraint system, ensure the strap is routed through the hole in the headrest before attaching and tensioning the strap to the anchorage point at the base of the seat.



! CAUTION!

- use images to demonstrate routing of the top tether.
- For details about how to install the CRS on the front passenger seat, see the preceding description.

Securing a child seat using the seat belt

- Only use child seats that are recommended by BYD, are universally approved, or are semi-universal and where the vehicle model is included on the child restraint manufacturer's vehicle list.
- Installation options are shown in the table below.

Group	Child Weight	Front passenger seat		Rear seat
		Front passenger front airbag activated	Front passenger front airbag deactivated	
0	up to 10 kg	X	U	U
0+	up to 13 kg	X	U	U
1	Rear facing	X	U	U
	Forward facing	U	X	U
2	15 to 25 kg	U	X	U
3	22 to 36 kg	U	X	U

Table definitions:

u: universal

x: seat not suitable for securing a child seat of this group.

Quick guide to ISOFIX and i-Size installation

- The identification marking of the ISOFIX or i-Size anchorage points is equipment and country dependent.
- The following table shows the installation options for ISOFIX or i-Size child seats at the ISOFIX or i-Size anchorage points of the individual vehicle locations.

Group	Child Seat Orientation	Size class/ ISOFIX class	Front passenger seat		Outer rear seat	Center rear seat
			Front passenger front airbag activated	Front passenger front airbag deactivated		
0: up to 10 kg	Rear facing	E/R1	X	IL-SU	IL-SU	X
0+: up to 13 kg	Rear facing	E/R1	X	IL-SU	IL-SU	X
		D/R2 C/R3				
1: 9 to 18 kg	Rear facing	D/R2 C/R3	X	IL-SU	IL-SU	X
		B/F2X B1/F2X A/F3				
2: 15 to 25 kg	Forward facing	-	IL-SU	X	IL-SU	X
3: 22 to 36 kg	Forward facing	-	IL-SU	X	IL-SU	X
i-Size child restraint system	Rear facing	-/R2	X	i-U	i-U	X
	Forward facing	-/B2, F2X	i-U	X	i-U	X
Booster seat	Forward facing	-/B2, B3	i-B	X	i-B	X

Size class:

- The size class shown corresponds to the permissible weight range of the child using the seat.
- The size class is indicated on the ECE approval label for child seats with "universal" or "semi-universal" approval.
- A size class indication is affixed to the child seat.

X:

- Seat not suitable for securing an ISOFIX or i-Size child seat in this group.

IL-SU:

- Seat suitable for installing an ISOFIX child seat with "semi-universal" approval.
- Refer to the vehicle list supplied by the child seat manufacturer.

IUF:

- Seat suitable for installing an ISOFIX child seat with "universal" approval.

i-U:

- Seat suitable for installing a front-facing or rear-facing i-Size child seat with "universal" approval.

i-UF:

- Seat suitable for installing a front-facing i-Size child seat with "universal" approval.

i-B:

- Seat suitable for installing a forward-facing ISOFIX booster seat of Group 2/3 as well as a forward facing i-Size child seat for children with a height of 100 – 150 cm (approximately 39 – 59 inches).

Anti-Theft System

Anti-Theft System

Anti-Theft System

If the vehicle is in anti-theft mode, it will sound an alarm and its turning lights will flash when any door is opened.



Enabling the Anti-Theft System

1. Set the ignition switch to OFF.
2. After all passengers have got out of the vehicle, lock the doors, and the anti-theft indicator light will be on. The anti-theft system is automatically enabled 10 seconds later. After the system is enabled, the anti-theft indicator starts to flash.
3. After ensuring that the indicator is flashing, the vehicle can be left. The anti-theft system is activated if a person opens or unlocks the door from inside the vehicle. Therefore, never allow anyone to remain in the vehicle while enabling the anti-theft system.

Triggering the Alarm

- The anti-theft system generates an alarm sound in any of the following cases:
 - Any door, trunk, or hood is opened without using the keyless access function of the smart key.

- The vehicle is powered on without using the keyless start function of the smart key.

Anti-theft OFF

- The alarm can be stopped by the following methods:
 - Use of a valid smart key to unlock the vehicle.
 - Use of an NFC to unlock the vehicle.
 - Use of the microswitch to unlock the vehicle.
 - Use of a valid smart key to remotely unlock the trunk.
 - Use of a valid smart key to remotely start the vehicle.
 - Pressing the Start/Stop button of the valid smart key inside the vehicle.

WARNING!

- Do not make any changes or additions to the anti-theft system. Such changes could cause the system to malfunction.

Anti-Theft Indicator

When the anti-theft system is enabled, the anti-theft indicator is steady on for 10 seconds.



Data Collection and Processing

Data Collection and Processing

- This section provides you with some important information on how personal data is collected and processed when you use a BYD vehicle.
- For a more detailed overview on data processing, data protection and data subject rights, please read the current version of the privacy policy for the vehicle available at the BYD website.

Vehicle Data Processing

- Data is collected when the vehicle is used, such as data collected or transmitted by vehicle sensors or control units, which is necessary for the safe functioning of your vehicle.
- In some cases, the data is used to support driving (driver assistance systems) or to enable a specific comfort or infotainment function.
- Personal data that is collected and processed mainly include in-vehicle data, remote-services-related data, and other data, as further specified below.

In-Vehicle Data

Operation data

- When the vehicle is used, various vehicle status data (e.g. speed, battery level, braking system) or the environment (e.g. distance sensors, rain sensor, temperature sensors) are collected and processed.

- This data is not usually stored, but there are control units, sensors or other components installed in the vehicle that record such data, for example to record maintenance requirements, error messages or other information.
- The in-vehicle data will only be stored in the equipment in the vehicle but can be read out via the legally required OBD ("On Board Diagnostics") interface, for example by BYD authorised dealer or service provider or other third parties.
- In case this access takes place during vehicle maintenance, the information can also be transmitted to BYD engineers for quality assurance, product defect reports or customer claim verification.

Remote-services-related data

Remote monitoring services

- This vehicle has remote monitoring services.
- These include remote monitoring services such as remote diagnosis and Over-the-air (OTA) updates and upgrades for security and safety purposes (subject to owner's approval).
- These monitoring services serve the following purposes: service provision (remote support/diagnostics), product development and security/public safety.
- Depending on the country and set-up, various vehicle information can be transmitted to BYD for the above purposes, including vehicle location information, vehicle status, such as energy consumption, vehicle speed, gear position, power mode, ESC status, steering system status, battery status, powertrain status and overall vehicle performance status.

Other

Infotainment system

- Depending on vehicle configuration, data can be added to the infotainment system by the users themselves, such as media data for playing video on the infotainment system, address data for use in the navigation system, or data for use in online services.
- Depending on vehicle configuration, individual settings in and on the vehicle can also be entered.
- Data stored in the vehicle can be deleted at any time.
- BYD has no control over data transferred to third parties (from the use of third party content, in particular as part of online services).

Integration of mobile devices

- Depending on vehicle configurations, mobile devices can be connected and controlled through the vehicle's infotainment system.
- It may be necessary that the device's screen or audio is displayed/played through the infotainment system or transmitted to it.
- Additional data like positioning or vehicle information can be transmitted through applications for use in certain navigation systems, communication, or other third-party services.
- The specific type of data processing depends on the respective function and is controlled by the user or third parties such as the provider of the devices or corresponding services.

Internet access and connected services



- Depending on vehicle configurations, the Internet can be accessed for certain functions or BYD services through the vehicle's infotainment system network devices.

- BYD is not liable for any such services provided by any other party.
- In such cases, obtain information about data use from the provider of the respective online service.

Cameras Image recording/surrounding area monitoring

- This vehicle is equipped with a number of cameras/sensors.
- The reason for this is that some vehicle functionalities require the vehicle's path to be detected and assessed, which is done by cameras that detect objects in the vehicle's surroundings (e.g. obstacles).
- The images are transmitted to the respective control module for further analytics required to operate the systems.
- Some images are just processed on a volatile basis (RAM), others may be stored, depending on vehicle equipment.
- The vehicle may be equipped with an Outward Facing Camera (OFC) that can be used to take footage of the surrounding (dashcam).
- The vehicle may also be equipped with an Inward Facing Camera (IFC), which can be used to take footage inside the vehicle.
- Both OFC and IFC footage is stored.
- It is the owner's responsibility to be aware of their country's corresponding laws before turning on their OFC or IFC cameras (for instance, in some countries consent is required for the use of IFC, and in others OFC is strictly restricted to dashcam purposes).
- For more details on camera options, go to the **Trip Record and Panoramic View** sections of this manual.

Permanent Vehicle Transfer to Third Parties and Off-Line Mode

- In case of permanent vehicle transfer, i.e. second hand vehicle, or vehicle transfer by a third party for permanent use, it must be noted that any personalization/user settings via the infotainment system (e.g. address list, navigation system etc.) may be accessed by the new user.
- Vehicle communication with the BYD data server can be restricted, and the processing of vehicle related and personal data can be set to vehicle offline mode.
- Tap on PAD  to turn Wi-Fi off.
- Wi-Fi can also be turned off by tapping on  → **DiLink** → **Link** → **WLAN** → **Off**.



Disclosure of Personal Data to Authorities

- BYD discloses personal data only insofar to third parties as this is legally permissible and upon user consent. However, subject to the applicable laws, government agencies may be authorised to access vehicle data (e.g. data from the airbag control unit to clarify an accident).
- If required by law BYD may also be obliged to disclose data upon government authority request, e.g. in the event of criminal offence investigation.

Data Protection Rights

- BYD has staunch respect for its customer's privacy, and strictly complies with all data protection laws, in particular the General Data Protection Regulation (GDPR) and applicable local laws.
- According to these laws, owners have specific rights when their personal data is processed:
- Data subjects have the right of information and access, to rectification, erasure of personal data ('right to be forgotten') and the right to object to the processing of personal data or to restrict it (or to withdraw consent given earlier, as well as the right to data portability).
- These rights may be limited in some cases, for instance, if it can be shown that there is a legal obligation to process data, or if provision of information would disclose someone else's personal data, or if there is a legal prevention from disclosing such information.
- In some cases, this may mean that data can be restrained even if consent is withdrawn.
- For more information on data processing, protection and any other rights, visit the latest version of the Privacy Policy available at the BYD website.

03

DASHBOARD

Instrument cluster36

Instrument Cluster

Instrument Cluster View

LCD Instrument Cluster



- | | | | |
|---|-----------------------------|----|---------------------------------|
| 1 | Time | 6 | Total mileage |
| 2 | Power meter | 7 | Driving range |
| 3 | Speedometer | 8 | Gear status |
| 4 | State of Charge (SOC) meter | 9 | Drive mode information |
| 5 | Outside temperature | 10 | Energy regeneration information |

Instrument Cluster Indicators

Indicators and Warning Lights

	Turn signals
---	--------------

	Light position indicator
---	--------------------------

	High beam indicator
---	---------------------

	Rear fog light indicator
---	--------------------------

	OK indicator
---	--------------

	Front fog light indicator*
---	----------------------------

	ECO indicator
---	---------------

	SPORT indicator
---	-----------------

	AVH indicator
---	---------------

	Hill descend control indicator*
---	---------------------------------

	Exterior light switch indicator
---	---------------------------------

	HMA indicator*
---	----------------

	Discharge indicator
---	---------------------

	Rain and light sensor indicator
---	---------------------------------

	ACC standby status indicator (Gray)*
---	--------------------------------------

	ACC speed indicator
---	---------------------

	ACC status indicator*
---	-----------------------

	AVH standby indicator (White)
---	-------------------------------

	Cruise control indicator
---	--------------------------

	Cruise control main indicator
---	-------------------------------

	Traffic Jam Assistant (TJA) indicator*
---	--

	Predictive Collision Warning (PCW) indicator (Green)
--	--

	Autonomous Emergency Braking (AEB) warning light*
---	---

	Smart key system warning light
---	--------------------------------

	Tire pressure warning light
---	-----------------------------



Main alarm indicator



ESC OFF warning light



ESC warning light



Anti-lock Braking System (ABS) warning light



Drive power limit warning light



Headlight warning light



Snow mode indicator



SOC low warning light



ACC warning light



Blind Spot Detection (BSD) indicator*



PCW warning light (Red)



Motor overheating warning light



Motor refrigerant overheating indicator



Unfastened seat belt warning light



Airbag warning light



Electronic Parking Brake (EPB) indicator



Parking brake system warning light



Steering system warning light



Power battery charging connection indicator



Low-voltage power system warning light



Power battery overheating warning light



Power battery warning light



Power system warning light



Road Sign Recognition (RSR) indicator*

Warning Light and Indicator Description



Smart key system warning light

- If the key is not in the vehicle when the power button is pressed, this warning will light up for a few seconds, a beep will be heard, and a "No key detected, please check whether the key is in the car" message will be displayed on the cluster.
- If an electronic smart key matching the vehicle is inside and the power button is pressed, the warning does not light up and the vehicle is powered on normally.
- If the warning light flashes when the power button is pressed, the battery of the smart key is low.
- If the key is not in the vehicle, the instrument cluster prompts "The key is not detected, please check whether the key is in the car".



ABS warning light

- When the ignition switch is on OK, this warning light goes on. If ABS is working normally, this warning light goes off in a few seconds. If ABS is faulty, the warning lights up again until the fault is cleared.
- When the ABS warning light goes on (the parking brake system warning light goes off), ABS is not working, but the braking system still works normally.
- When ABS is not working, wheels will be locked in emergency braking or braking in slippery roads.
- If any of the following cases occurs, it means there is a fault in components monitored by the warning light system. In such case, contact a BYD authorized dealer or service provider as soon as possible.

- When the ignition switch is on OK, this warning light does not go on or is steady on.
- This warning light goes on while driving.



REMINDER

- A warning light that lights up briefly during operation does not indicate that there is a problem.
- If the parking brake system warning light and the ABS warnings light up at the same time, immediately stop the vehicle safely and contact a BYD authorized dealer or service provider. In this case, when the brake is applied, not only will the anti-lock braking system fail to work, but the car will also become extremely unstable.
- If both the ABS warning light and braking system warning lights go on after the EPB is released, it indicates that the Electronic Brake-Force Distribution (EBD) system of the front and rear tires has also failed.



Tire pressure warning light

- When the ignition switch is on OK, this warning lights up. It goes off in a few seconds if the tire pressure monitoring system (TPMS) works normally. If the system is faulty, this warning light goes on again.
- When the tire pressure warning light is on or flashing, the instrument cluster displays "Please check the tire pressure monitoring system", and the tire pressure is displayed as "---" on the screen, it indicates that the TPMS is faulty.
- When the TPMS displays "Signal Abnormal", it indicates that the tire pressure signal at the location of the vehicle may be disturbed or the TPMS module is damaged.

- When the tire pressure warning light flashes quickly, and one or more tire pressures displayed on the meter turn red, it indicates that the corresponding tire is leaking fast.
- When the tire pressure warning light is steady on, and one or more tire pressures displayed on the instrument cluster turn yellow, it indicates that the corresponding tire pressure is too low. When the temperature of one or more tires turn yellow, it indicates that the tire temperature is too high.

If any of these cases occurs, contact a BYD authorized dealer or service provider for inspection as soon as possible.



Electronic Stability Control (ESC) warning light

- When the ignition switch is on OK, this warning light goes on. If the ESC function is working normally, this warning light goes off in a few seconds. If the ESC system is faulty, this warning light goes on again until the fault is cleared.
- If the ESC warning light flashes while driving, it indicates that the ESC system is working.
- If the ESC warning light goes on (the ABS warning light and parking brake system warning lights go off), there is ESC fault, but the ABS and braking system still work normally.
- When the ESC function fails, the vehicle will be extremely unstable when making sharp turns and avoiding obstacles.
- If any of these occurs, a component monitored by the warning light system may be faulty. In this case, contact a BYD authorized dealer or service provider for inspection as soon as possible.

- When the ignition switch is on OK, this warning light does not go on (and self-check is not performed).
- This warning light is steady on while driving.
- If this warning light flashes while driving, it indicates that the ESC system is working.

REMINDER

- During operation, a warning light that lights up briefly does not indicate that there is a problem.
- If the ESC warning light is still on while the ABS warning light and the brake system warning light are on, stop the vehicle safely and contact a BYD authorized dealer or service provider. In this case, when the brake is applied, not only will the car become extremely unstable, but the anti-lock braking system will not work at all.



ESC OFF warning light

- When the ESC OFF switch is pressed, the ESC OFF warning light goes steady on, and the ESC function will not work. When the ESC OFF switch is pressed again, this warning light goes off, and the ESC function recovers.

REMINDER

- If the ESC OFF warning light is on, the driver must be alert and maintain a slow driving speed in sharp turns and when avoiding obstacles. In this case, when the brake is applied, the ESC system function will not work, and the car will become unstable.



Drive power limit warning light

When the power of the vehicle is limited, this warning light goes on. In this case, contact a BYD authorized dealer or service provider in time.



Headlight warning light

- If this warning light turns yellow, it indicates that the headlight is faulty. In this case, take the vehicle to a BYD authorized dealer or service provider for inspection.



Main alarm indicator

- If this indicator goes on, check the fault prompt or warning information in the information display area.



Unfastened seat belt warning light

- When the ignition switch is on OK, if any seat belt on the front row is not fastened, the corresponding seat belt indicator will be on. The indicator does not go off unless the seat belt is fastened.



Airbag warning light

- When the ignition switch is on OK, this warning light goes on. It goes off in a few seconds if the airbag system works normally. This warning light is used to monitor the ECU, crash sensor, inflator, warning light, wiring, and power supply of airbags.

- If any of the following cases occurs, a component monitored by the warning light system may be faulty. In this case, contact a BYD authorized dealer or service provider for inspection as soon as possible.
 - When the ignition switch is on OK, this warning light does not go on, or is steady on.
 - This warning light goes on while driving.



Parking brake system warning light

When the brake fluid level is low or the brake system is faulty, this warning light goes on. If any of these cases occurs, stop immediately and contact a BYD authorized dealer or service provider.

- When the ignition switch is on OK and the brake fluid level is low, this warning light goes on.

! REMINDER

- When the brake fluid level is low, park the vehicle because it is dangerous to continue driving.
- After starting the vehicle, if the brake fluid level is normal and the EPB is working normally (the EPB switch can be pulled up and released normally, and the prompt "Please check the EPB" is not displayed), the warning light is steady on.
- Both the parking brake system warning light and ABS warning light go on.

REMINDER

- If this warning lights up briefly during operation, it does not indicate that there is a problem.



Steering system warning light

- If the steering system becomes faulty, this warning light is steady on. In this case, send the vehicle to a BYD authorized dealer or service provider for inspection.

REMINDER

- The steering system features an electric motor to reduce the force required to turn the steering wheel.
- When turning the steering wheel, a hum may be heard coming from the running motor. This does not indicate that the motor is faulty.
- Do not turn the steering wheel to its limit position for more than 5 s, otherwise the temperature protection will be activated and the steering system will be damaged or steering will become heavy.
- If the steering wheel is frequently turned when the vehicle does not move, its power assist effect will be reduced to prevent steering system overheating.
- Therefore, it may feel difficult to turn the steering wheel even if the warning light does not go on. In this case, reduce steering frequency or power off the vehicle, and the system will recover within 10 minutes.

WARNING

- If the steering system warning light goes on, immediately park the vehicle safely, and contact a BYD authorized dealer or service provider.



Low-voltage power system warning light

- In non-charging or discharging state, this warning light indicates the working state of the DC module and the battery module.
- In charging state, this warning light indicates failure of the charging system.
- If this warning light goes on while driving, the DC system or low-voltage power supply system is faulty. In this case, turn off the A/C and fans, immediately park the vehicle safely, and contact a BYD authorized dealer or service provider.



Power system warning light

- This warning light goes on if the power system becomes faulty.
- If any of these cases occurs, a component monitored by the warning light system may be faulty. In this case, contact a BYD authorized dealer or service provider for inspection as soon as possible.
 - When the ignition switch is on OK, this warning light is steady on.
 - This warning light goes on while driving.

CAUTION

- Try not to drive the vehicle when the warning light is on. Contact a BYD authorized dealer or service provider to check the problem as soon as possible.



Power battery overheating warning light

- If this warning light goes on, the battery temperature is too high. In this case, park the vehicle to cool it down. If this warning light flashes, park the vehicle in a safe place immediately, and leave the vehicle.
- The power battery may be overheated when the vehicle:
 - Drives up a slope for a long time in hot weather.
 - Frequently stops and goes, frequently accelerates, brakes suddenly, or runs for a long time without pause.



Power battery warning light

- This warning lights up just as ignition goes on OK. It goes off if the power battery works normally. Later, if the system becomes faulty, this warning light goes on again. In this case, contact a BYD authorized dealer or service provider for inspection as soon as possible.
- If any of these cases occurs, a component monitored by the warning light system may be faulty. In this case, contact a BYD authorized dealer or service provider for inspection as soon as possible.
 - When the ignition switch is on OK, this warning light is steady on.
 - It is still on or occasionally goes on while driving.

















Motor refrigerant overheating indicator

- If this indicator goes on, the motor temperature is too high. In this case, park the vehicle in a safe place immediately, leave the vehicle, and contact a BYD authorized dealer or service provider for inspection as soon as possible.

Description of Other Instrument Faults

The instrument cluster may display the following error messages. Handle them according to the recommended handling methods.

Symbol	Error Message	Handling
	Please check the on-board charging system.	The on-board charging system is faulty. In this case, check the charging connection, and reconnect the charging equipment. If the fault persists, contact a BYD authorized dealer or service provider.
	Please check the data network of the vehicle.	The vehicle may be disconnected from the data network. In this case, park the vehicle immediately, and contact a BYD authorized dealer or service provider.
	Please check the headlight.	The headlight is faulty. In this case, contact a BYD authorized dealer or service provider.
	Please check the PCW system.*	The PCW system is faulty. In this case, park the vehicle, and contact a BYD authorized dealer or service provider.
	The AEB function is limited.*	The AEB system is faulty. In this case, park the vehicle, and contact a BYD authorized dealer or service provider.
	Please check the BSD system.*	The BSD is faulty. In this case, park the vehicle, and contact a BYD authorized dealer or service provider.
	The BSD function is limited.*	The BSD function is limited. In this case, park the vehicle, and contact a BYD authorized dealer or service provider.
	Please check the shifter.	The shifter controller is faulty. In this case, park the vehicle immediately, and contact a BYD authorized dealer or service provider.

	Please check the infotainment system.*	The infotainment system is faulty. In this case, park the vehicle, and contact a BYD authorized dealer or service provider.
	The function of the infotainment system is limited.*	The function of the infotainment system is limited. In this case, park the vehicle, and contact a BYD authorized dealer or service provider.
	The smart camera is unavailable.*	The smart camera is unavailable. In this case, park the vehicle, and contact a BYD authorized dealer or service provider.
	Please check the LDWS.*	The Lane Departure Warning System (LDWS) is faulty. In this case, park the vehicle, and contact a BYD authorized dealer or service provider.
	Please check the ICC or LKS.*	The Intelligent Cruise Control (ICC) or Lane Keeping System (LKS) system is faulty. In this case, park the vehicle, and contact a BYD authorized dealer or service provider.
	The function of the ICC or LKS is limited.*	The function of the ICC or LKS is limited. In this case, park the vehicle, and contact a BYD authorized dealer or service provider.

04

CONTROLLER OPERATIONS

Car Doors and Keys.....	48
Seats	59
Steering Wheel	62
Switches	65

Car Doors and Keys

Introduction to Keys

Keys include the electronic smart key, mechanical key (installed in the electronic smart key), and Near Field Communication (NFC) key card*.

Electronic Smart Key

Press the left/right front door microswitch to unlock or lock all doors, or press other smart key buttons to lock/unlock doors, open trunk, and start the vehicle remotely.

- (1) Indicator
- (2) Lock button
- (3) Unlock button
- (4) Trunk opening button
- (5) Start/Stop button
- (6) Mechanical Key

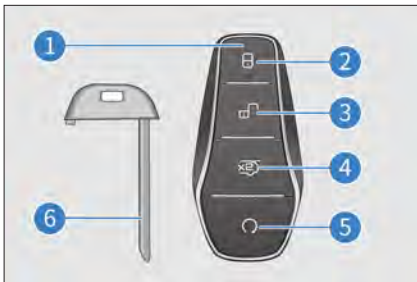

CAUTION

- The smart key is an electronic component. Observe the following instructions to prevent damage:
 - » Do not expose the smart key to high temperatures, such as on the dashboard.

CAUTION

- » Do not disassemble the smart key without authorization.
 - » Do not let the smart key hit other objects or fall down.
 - » Do not let the smart key get wet.
 - » Keep the smart key away from electromagnetic wave emitting devices, such as smartphones.
 - » Do not attach any object (such as a metal seal) that may cut off electromagnetic waves when using the smart key.
 - » Register a spare key for the same vehicle. For details, contact a BYD authorized dealer or service provider.
- If the smart key fails to control the doors within the normal distance, or if the indicator on the key is dim or off:
 - » Check for nearby radio stations or airport radio transmitters that may interfere with the normal operation of the smart key.
 - » The smart key battery may be exhausted. Check the smart key battery. If the battery needs to be replaced, contact a BYD authorized dealer or service provider.
 - If the smart key is lost, contact a BYD authorized dealer or service provider as soon as possible to prevent theft or accidents.
 - Do not change the transmission frequency, increase the transmission power (including installing an extra amplifier), connect an external detection antenna, or use other transmission detection antennas without authorization.

⚠ CAUTION

- Do not generate harmful interference to legal radio communication services when using the smart key. Once any interference is found, stop using the smart key immediately, and take measures to eliminate the interference before continuing to use it.
- When using a micropower radio device, avoid the interference from various radio services or the radiation interference from the equipment in industrial, scientific and medical applications.
- Do not use such device near an airplane or airport.
- People with pacemakers or defibrillators should stay away from the detection antennas of the smart access and start system, because electromagnetic waves may interfere with the normal functioning of these devices.
- In addition to people with pacemakers or defibrillators, people using other electronic medical devices should also consult the manufacturer on the use of such medical devices under the influence of electromagnetic waves. Electromagnetic waves may have unpredictable consequences for the use of such medical devices.
- Upon leaving the vehicle, make sure to carry the key and lock the vehicle at any time. Never leave anyone (especially children) inside the vehicle.

Mechanical key

Use the mechanical key (inside the smart key) to lock or unlock the main car door. Insert the mechanical key back into the smart key when it is not in use.

Removing the Mechanical Key

Press the latch (2), pull the locking structure in the desired direction (1), open the back cover of the key upward, and take out the mechanical key.



- Press the latch (2) and insert the mechanical key back into the smart key when it is not in use.

Mechanical key number plate

- The mechanical key number is marked on the number plate. If the key is lost or needs to be copied, use the key number to copy it at a BYD authorized dealer or service provider.



ⓘ REMINDER

- Be sure to store the number plate in a secure place for safekeeping; do not put it in the car.
- It is recommended that the user records the key number and stores it in a safe place.

NFC Key Card*

- Hold the NFC key card close to the NFC sign on the right side mirror. Then, all doors can be unlocked or locked when the vehicle is powered off.

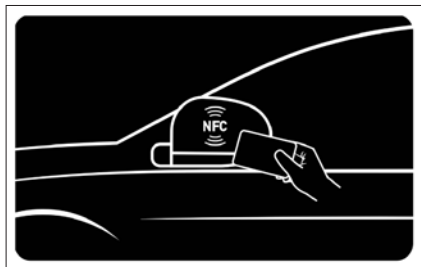

CAUTION

- The NFC card is an electronic product. To prevent NFC card malfunction or damage to the NFC card, the following instructions should be followed:
 - » When a wireless charger is on, do not place the NFC card in the charging area.
 - » Do not attach any object (such as a metal seal or metal phone case) that may cut off electromagnetic waves when using the NFC card.
 - » Do not expose the NFC card to high temperatures, such as on the dashboard.
 - » Do not bend the NFC card.
 - » Do not put the NFC card together with other hard objects.
- The NFC card is for near field communication, and identification requires a complete fit, so it is necessary to pay attention to the position of the NFC.
 - » The identification distance of the NFC card is within 1 - 2 cm.

CAUTION

- » For successful NFC card identification, it may be necessary to stick it on the side mirrors.
 - » Identification may take 1 to 2 seconds.
- The NFC smart card is a key configured for the vehicle based on the near field communication safety method. In order to ensure vehicle safety, handle it with care. If it is lost, go to a BYD authorized dealer or service provider to get a newly configured card and block the lost one.

Locking/Unlocking Door

Locking/Unlocking with Mechanical Key

Insert the key into the key hole, turn and remove the key, and pull the door handle to open the door.

- To unlock the driver's door, turn the key clockwise.
- To lock the driver's door, turn the key counterclockwise.

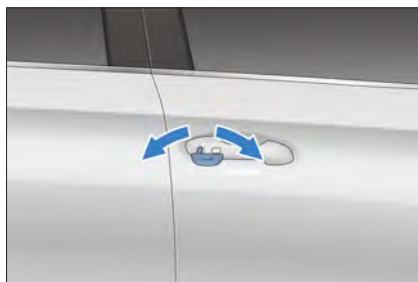

CAUTION

- After removing the mechanical key, pull the main door handle to open the door.

Opening Car Door with Interior Door Handle

- When the vehicle is unlocked, pull the handle once to open the door from inside the vehicle.
- When the vehicle is locked, pull the handle twice to open the door from inside the vehicle.

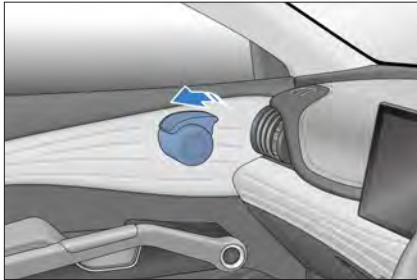

WARNING

- Do not allow children to play with the door handle, so as to avoid the door opening while driving.
- If there are children in the vehicle, make sure to enable the child protection lock function.

CAUTION

- As this vehicle is equipped with a child protection lock, the rear doors can only be opened with the interior handle when the child protection lock is disabled.

Locking/Unlocking with Smart Key

- The wireless remote control function is used to unlock or lock all doors at close range, and complete additional functions.
- In the active area, press the button on the registered smart key to lock or unlock all doors.

Locking:

- When the ignition switch is on OFF and all the doors and hood are closed, press the Lock button. All doors then lock, side mirrors fold in (the switch is set to AUTO), and the turning lights flash once. Check that all doors are locked.
- If any door, hood, or trunk is not closed, the turning lights do not flash, and the horn beeps once.



Unlocking:

- To unlock all doors, press the microswitch on the door handle while carrying a valid smart key. All doors will unlock, side mirrors will unfold*, and turning lights flash twice.
- When the ignition switch is ON, doors cannot be unlocked with the lock or unlock button.
- When all doors are unlocked with the electronic smart key, even if they are not opened, the interior lights may be on ("Door control" on the interior light switch goes on) for 16 seconds and then turn off.

- When anti-theft mode is activated, if no door is opened within 30 seconds after all doors have been unlocked with the smart key, they will lock automatically.
- If the smart key is left inside the cabin or trunk of the locked vehicle, and the door or trunk is closed, the vehicle will unlock automatically and the turning lights will flash twice.
- If the vehicle is equipped with four-door anti-pinch function and the lock/unlock button is pressed for a long time, locking/unlocking will not be repeated. It is necessary to release this button and press lock/unlock again. When the lock button is pressed and held, the vehicle's four windows will automatically rise.

REMINDER

- If the ignition switch is not on OFF, the Lock or Unlock button cannot be used to lock or unlock doors.

Opening Trunk with Smart Key

- Press the smart key trunk unlock button twice to open the trunk. The turning lights will flash twice.

REMINDER

- Don't forget to carry the smart key when leaving the vehicle.

Smart Key Car Search

- If the vehicle is in anti-theft mode, it will generate a long beep and the turning lights will flash 15 times when the lock button is pressed, in order to confirm the vehicle's location when it cannot be found.
- When the vehicle is in the car search mode, press the Lock button again and the vehicle enters the next car search mode.

Raising/Lowering Windows with Smart Key

- When the ignition switch is on OFF:
 - Press and hold the smart key lock button to raise the four windows.
 - Press and hold the smart key unlock button to lower the four windows.

WARNING

- When using the remote control function to raise windows, pay attention to the safety of occupants in the vehicle, and use this function only after making sure the windows are clear from pinching anyone.

REMINDER

- Users can turn this function on/off by pressing and holding the smart key lock/unlock button and open/close windows through  → Vehicle Settings → Doors, Windows and Locks Settings interface (depending on actual vehicle configuration).

Locking/Unlocking with Microswitch

Locking

- When the ignition switch is on OFF and all doors are closed but not locked, press the front door handle microswitch while carrying the smart key to lock all doors. The turning lights will flash once.
- If any door, hood, or trunk is not closed, the microswitch can be used to lock the closed doors. The turning lights will not flash but the horn will beep once.

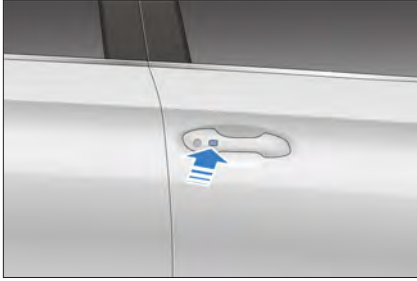

Unlocking

- In anti-theft mode, press the front door handle microswitch while carrying the smart key to unlock all doors. The turning lights will flash twice.
- When anti-theft mode is activated, if no door is opened within 30 seconds after all doors have been unlocked with the microswitch, they will lock automatically.
- Pressing the microswitch will not lock or unlock doors when:
 - The microswitch is pressed while opening or closing a door.
 - The ignition switch is not on OFF.
 - The smart key has been left inside the vehicle.

REMINDER

- If the smart key is too close to the exterior door handle or window, the entry function may not be activated.

Raising/Lowering Windows with Microswitch

- When the ignition switch is OFF, press and hold the front door handle microswitch while carrying the smart key to roll up or down all windows. (Tap on Vehicle Settings → Window and Lock Settings in the infotainment system to enable or disable this function.)

Locking/Unlocking with NFC Key Card*

- Hold the NFC card close to the NFC sign on the right side mirror.

Locking doors:

- When the ignition switch is OFF and doors are closed but not locked, hold the NFC card close to the NFC sign on the right side mirror to lock all doors. The turning lights will flash once.

Unlocking doors:

- In anti-theft mode, hold the NFC card close to the NFC sign on the right side mirror to unlock all doors. The turning lights will flash twice.
- When anti-theft mode is activated, if no door is opened within 30 seconds after all doors have been unlocked with the NFC card, they will lock automatically.
- After unlocking doors with the NFC card, user activation permission is provided for 10 minutes. This permission will be revoked when the ignition switch is on OFF.
- In any of the following cases, doors are not locked or unlocked when the NFC card is held close to the NFC sign on the right side mirror:
 - Doors are opened or closed while the NFC card is held close to the NFC sign on the right side mirror.
 - The ignition switch is not OFF.

CAUTION

- The keyless ignition permission validity period does not exceed 10 minutes.

Locking/Unlocking Trunk Lid

Using the smart key to open or close the trunk lid

When the vehicle is equipped with the electric tailgate system, press the smart key trunk unlock button twice to open the trunk lid. The turning lights will flash twice. Press the button twice again to stop lid motion, and twice again for it to move in the opposite direction.



! REMINDER

- If the trunk unlock button is pressed again while the lid is in motion, it will stop at its current position.

Opening or closing the trunk lid from inside the vehicle*

- When the trunk lid is closed, pull this switch once to open the trunk to the set position (default maximum height).
- If the switch is pulled again while the lid is in motion, it will stop at its current position.



- When the trunk lid is open and the switch is pulled for more than a second, the lid closes automatically. The lid stops closing after the switch is released.

Opening the trunk lid with the exterior switch

- When the vehicle is locked, press the trunk lid external switch while carrying the smart key to open the trunk.

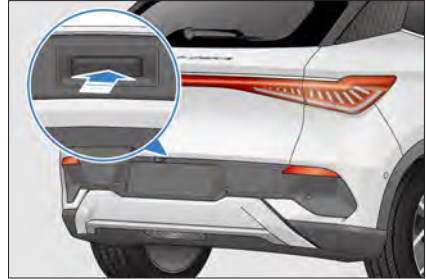

! REMINDER

- If the switch is pressed again while the lid is in motion, it will stop at its current position.

Closing the trunk lid automatically*

(1) Trunk locking switch*

When the trunk is open and the lid still, pressing the lid switch will close the trunk automatically.

If the switch is pressed again while the lid is closing, it will stop at its current position. If the switch is pressed again, the lid will move in the opposite direction.

(2) Vehicle locking button*

When the ignition switch is OFF and the trunk is open, press the lock button while carrying the smart key to close the trunk. The vehicle locks and enters anti-theft mode.



Manually closing the trunk lid*

When the vehicle is unlocked, the trunk can be closed manually.

CAUTION

- Before closing the trunk electronically, make sure doors, windows and sunroof are properly closed.

Emergency Unlock Trunk Lid from inside the Vehicle

There is an emergency unlocking cover just above the trunk lock. Open the cover and pull the emergency unlocking rope or lever to open the trunk in an emergency.



REMINDER

- When the vehicle is powered off, the trunk lid can be unlocked from the inside in case of emergency.

Setting the trunk lid opening height*

- Stop the opening lid motion at the desired position. Press and hold the lid switch for at least 3 seconds to set lid height. There will be a beep to indicate that the height has been successfully set.
- Tap on Vehicle Settings → Window and Lock Settings in the infotainment system to set the trunk lid opening height.

Anti-Pinch Function

If the lid receives a hindering force while it is closing, it will automatically switch motion to the opposite direction. If it receives a hindering force while it is opening, it will halt its motion.

If the electric trunk lid function fails

If the electric trunk lid function fails, manually close it completely and the function will recover.

When the battery is reconnected

When the battery is reconnected, close the trunk manually and the electric function will return to normal.

WARNING

- In order to prevent serious injury, make sure to observe the following precautions:
 - » Never try to deliberately activate the anti-pinch function.
 - » Make sure to alert people nearby of the lid motion.
 - » Make sure hands and fingers are clear from the lid area when it is closing.
 - » When opening or closing the trunk, make sure the surrounding area is safe.
 - » Make sure the trunk is properly closed when the vehicle is in motion.

! WARNING

- » Make sure to remove any ice or snow from the area before opening the trunk, otherwise the lid may close again.
- » Do not manually interfere in lid motion when it is opening or closing.
- » Be mindful of windy conditions when opening or closing the trunk.
- » The anti-pinch function may fail to work if an object is caught right before the trunk is fully closed.
- » Opening or closing the trunk on slopes is more difficult than on level ground. The lid may start closing before fully opening. Be mindful of the possibility of the lid to move on its own in such conditions. Before loading or unloading the trunk, make sure the lid is fully open and secure.
- » The anti-pinch function may fail depending on object shape. Be specially careful about hand and fingers.

Locking/Unlocking with Center Console Door Lock

Using the center console door lock to lock or unlock the vehicle

For details, see "**Center Console Door Lock**" in this chapter.

Automatically locking and unlocking doors

- When the function setting is enabled in the PAD, the vehicle is in OK gear, and the vehicle speed changes from ≤ 8 km/h to > 8 km/h, if all of the car doors are closed, but any car door is not locked, it will command electric locking of all four door locks.

- Press the Start/Stop button, and change the ignition switch from OK to OFF. Then, all doors are unlocked automatically.

Locking and unlocking all doors concurrently

- If the vehicle does not enter the anti-theft mode after it is locked, the center console door lock back light goes on, and off when the vehicle is unlocked.
- When the center console door lock is pressed, all doors are locked, and any attempt to open any door from the outside fails. The interior handle must be pulled twice to open a door.

Emergency Locking of All Doors with Mechanical Key

When the center console lock system or the smart key fails, the mechanical key can be used for emergency locking or unlocking.

Locking

1. Remove the mechanical key from the smart key.
2. The three doors other than the driver's door can be locked by moving down the slider with the mechanical key (as shown) and closing the door.



3. After locking the three doors, open the driver's door.

4. Insert the mechanical key into the keyhole, turn it counterclockwise as far as it can go, return it to the initial position and pull it out. (For details, see **"Locking/Unlocking with Mechanical Key"** in this chapter.)

Unlocking

1. Remove the mechanical key from the smart key.
2. Insert the mechanical key into the keyhole, turn it clockwise as far as it can go, return it to the initial position and pull it out.
3. Pull the interior handle to unlock and open the three other doors.

Smart Access and Start System

Use the smart key to lock/unlock doors and start the vehicle.

Access Function

Use the smart key to unlock or lock the vehicle doors. (For details, see **"Locking/Unlocking with Smart Key"** in this chapter.)

Start Function

With the smart inside, press the brake pedal and the power button to start the vehicle. (For details, see **"Starting inside the Vehicle"**.)

Antenna positions

- ① Interior antenna
- ② Exterior antenna

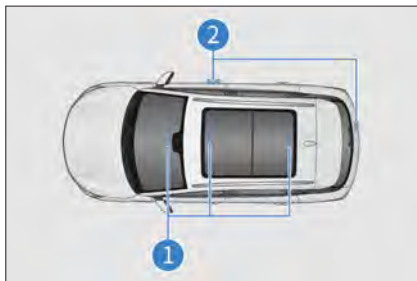

Active area

The smart access and start functions take effect only when the registered smart key is within the active area.

- ① Active area of the access function: about 1 m from the front door handle and the exterior trunk switch.
- ② Active area of the start function: inside the cabin.

If another smart key is near this vehicle's smart key, unlocking may take longer than usual, which is normal.

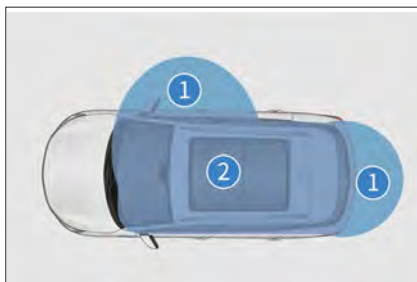

! REMINDER

The smart access and start system may not work properly when:

- There is a strong electromagnetic field nearby, such as TV towers, power stations, and broadcasting stations.

REMINDER

- The smart key is being carried along with a communication device, such as a two-way radio or mobile phone.
 - The smart key is in contact with or covered by a metal object.
 - The door handle is operated too quickly.
 - The smart key is too close to the handle.
 - Another wireless remote control function is being used nearby.
 - The smart key battery is exhausted.
 - The smart key is close to high-voltage equipment or equipment that produces noise.
 - The smart key is being carried along with another smart key or radio-wave-emitting device.
 - Even within the active area, the smart key may not work properly in certain locations, for example, on the dashboard, in the glove box, or on the floor.
-
- If the smart access system is not working properly and it is impossible to enter the vehicle, the mechanical key can be used to lock/unlock the driver's door, or the wireless remote control function can be used to lock/unlock all doors.
 - When the power button is pressed, the start function may fail due to:
 - Smart key failure. If the smart key warning light on the instrument cluster goes on, and the instrument cluster displays the message "Smart key power is low. Please replace the battery as soon as possible", the battery of the key may be exhausted.

- The smart access and smart start systems cannot work normally due to system failures. In this case, bring all smart keys to a BYD authorized dealer or service provider for repair.

Saving battery power

- The smart key communicates with the vehicle even when the vehicle is not running. Therefore, do not leave the smart key in the vehicle or within 2 m from the vehicle.
- If the smart key receives strong electromagnetic waves for a long time, its battery power will be quickly exhausted. The smart key must be kept at least 1 m away from the following devices:
 - TVs
 - PCs
 - Wireless telephone chargers
 - Electroliers
 - Fluorescent desk lamps

Child Protection Lock

The child protection lock is designed to prevent children sitting in the rear seats from opening the rear doors. Child protection locks are installed on the left and right rear doors.

- ① Slide the manual lock in this direction to activate either left or right child protection lock.
- ② Slide the manual lock in this direction to deactivate either left or right child protection lock.

Set the lever to this position marked (1). Then, passengers cannot open the rear doors from inside the vehicle. To open the rear doors, use the exterior door handles.

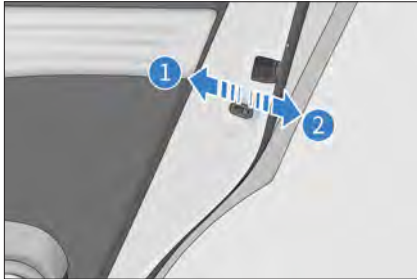

CAUTION

- Before driving, especially when there are children in the car, make sure that doors are closed and the child protection lock is enabled.
- Proper use of seat belts and the child protection lock helps prevent the driver and passengers from being thrown out of the vehicle in the event of an accident, and prevent the doors from being opened accidentally.

Seats

Seat Information

When the vehicle is moving, all passengers in the vehicle must fasten their seat belts, and rest their backs against upright backrests.

WARNING

- Do not drive until all passengers are seated properly.
- Passengers are not to ride sitting on folded seat backrests, in the trunk or on luggage, under risk of severe injury in case of an accident.
- Passengers are not to stand or move around in the cabin when the vehicle is in motion, under risk of serious injury in case of collision.

CAUTION

- Drivers must adjust the seat, steering wheel and dashboard panel control so that they have easy access and control of pedals, steering and controls.

REMINDER

- Drivers are not to make any adjustment of the seat or steering wheel while the vehicle is in motion, under risk of vehicle control impairment.
- When adjusting the seat, make sure there is ample room for the seat to move without obstruction.
- After manually adjusting the seat forward or backward, make sure it is locked into place.

! REMINDER

- After adjusting the seat backrest, make sure it is locked into place.
- Do not place anything under the seat, as this might affect its locking mechanism and cause it to move while driving, thus impairing proper vehicle control.
- Hands are to be kept away from under the seat or its moving parts when the seat is being adjusted.

Front Seat Adjustment

Front Seat Electronic Adjustment*

Electronic adjustment of front seats includes adjustment of the forward/backward, cushion up/down, and backrest angle. Depending on the actual configuration of your vehicle, the following adjustment methods are available:

(1) Seat position adjustment switch

- Slide this switch forwards/backwards to adjust seat distance from the dashboard.
- Pull up/push down the switch to adjust driver seat height.

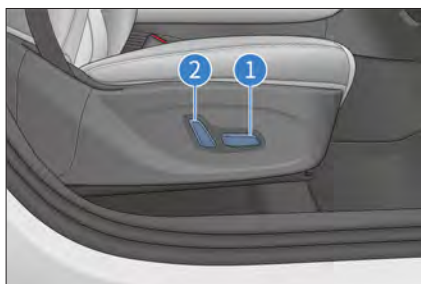

(2) Backrest angle adjustment switch

Pull/push the upper end of this switch to adjust backrest angle.

! CAUTION

- When the switch is released, the seat stops at its current position. Do not place anything under the seat that may interfere with its adjustment.

Heating System*

- Tap on the corresponding keys on the multimedia screen to enable and disable front seat heating
- Find the seat heating setting button from the "drop-down list" on the multimedia homepage.



Heating system adjustment

- Seat heating: users can select between high and low seat heating modes from the seat heating control button.
- Seat heating is always off when the vehicle is powered on.
- Seat heating will be on high mode when the button is first tapped on. The two indicators light up.
- Seat heating will be on low mode when the button is tapped on a second time, with only one indicator lit up.
- Seat heating will be disabled when the button is tapped on a third time. Both indicators will be off.

Folding in Rear Seats

- Flipping and lowering the backrest
 - Pull up the backrest drawstring.
 - Push the backrest forward or backward to flip it over. Flip forward until the backrest is in contact with the seat cushion, and flip it back to the backrest locking position (a locking sound is heard).



Head Supports

Head Support Adjustment

1. Lifting the head support: press the head support adjustment button, lift the head support to a proper position, and release this button after hearing a locking sound.
2. Lowering the head support: press the head support adjustment button, lower the head support to a proper position, and release this button after hearing a locking sound.
3. Removing the head support: press the head support adjustment button, remove the head support, and release this button.

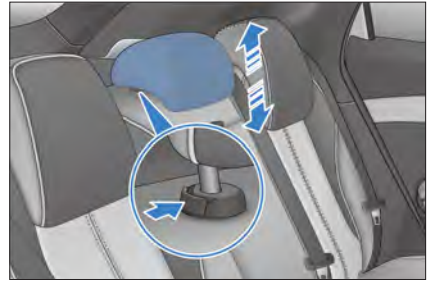

4. Installing the head support: insert the head support poles into the bushing with the grooves facing forward. Press the head support adjustment button, press the head support down to a proper position, and release this button.

! REMINDER

- The head supports protect vehicle occupants from neck and other head injuries. The head support is to be adjusted so that the back of the passenger's head is in the center of the head support. This way the head support can provide maximum protection. Adjust the head support to the suitable position according to the occupant's actual height.
- When adjusting head support height, align the occupant's ear tip line with the center line of the headrest.
- After adjusting the head support, ensure that it is locked into position.
- Do not drive the vehicle without head supports.
- Do not tie anything to the head support stems.

Steering Wheel

Steering Wheel Switch Group



- | | | | |
|---|-----------------|----|-------------------|
| 1 | Panoramic view* | 8 | Call |
| 2 | Screen mode | 9 | Voice recognition |
| 3 | ACC | 10 | Right |
| 4 | Distance+* | 11 | Mode |
| 5 | Lever | 12 | Roller |
| 6 | Distance-* | 13 | Instrument/Back |
| 7 | ICC | 14 | Left |

When the ignition switch is on OK, the audio control switch is available.

Buttons on the left

ACC switch*

- Press this button to enable or disable the ACC system.

REMINDER

- For instructions on how to use cruise control, see **"ACC System Setup"**.

+ /Reset*

- Press this button to activate the ACC system, and use the previous system settings.

- /Setup*

- Press this button to configure the current vehicle speed as the target speed for cruise control.

Distance-*

- Press this button to reduce the distance by one notch when the ACC function is enabled. A total of four notches are available.

Distance+*

- Press this button to increase the distance by one notch when the ACC function is enabled. A total of four notches are available.

Cancel

- Press this button to change the ACC mode from active to standby.

ICC

- Press this button to enable or disable the ICC function.

Screen mode

- Press this button to switch between the landscape and portrait mode of the infotainment system touchscreen.

Panoramic view*

- Press this button to enable/disable panoramic mode.

Buttons on the right

Roller

1. Infotainment system

- Turn the roller upward to increase volume.
- Turn the roller downward to decrease volume.
- Press the roller to mute.

2. Instrument cluster

- Turn the roller upward to select the upper level-2 or level-3 menu items in the instrument cluster menu mode.
- Turn the roller downward to select the lower level-2 or level-3 menu items in the instrument cluster menu mode.
- Press the roller:
 - To enter the next-level menu or confirm the current setting in the instrument cluster menu mode.

Left/Right button

1. Infotainment system

- In radio mode:
 - Press and hold the ◀ button to automatically search for the previous radio station with a strong signal (turning frequency down).
 - Press the ◀ button to select the pre-saved radio station upward.
 - Press and hold the ▶ button to automatically search for the next radio station with a strong signal (turning frequency down).
 - Press the ▶ button to select the pre-saved radio station downward.

- In USB/Bluetooth music/third-party music app mode:
 - Press the ◀ button to play the previous track.
 - Press the ◀ button to select a record upward on the Bluetooth call record or phone book screen.
 - Press the ▶ button to play the next track.
 - Press the ▶ button to select a record downward on the Bluetooth call record or phonebook screen.

2. Instrument cluster

- In instrument cluster menu mode:
 - Press the ◀ button to switch to level-1 menu and its submenus to the left.
 - Press the ▶ button to switch to level-1 menu and its submenus to the right.

Call

- Press this button to make or receive a call. (After this button is pressed, the audio system is muted.)
- When a screen unrelated to Bluetooth is currently displayed, press this button to switch to the phone selection screen if Bluetooth is disconnected, or to the main dialing interface if Bluetooth is connected.
- After entering a phone number on the main dialing interface or selecting a record on the call history or phonebook screen, press this button to dial the number.
- When Bluetooth is connected, but no phone number is entered on the main dialing interface, press this button to switch to a dialed number on the call history screen. Press this button again, and the system automatically calls the first dialed number on the call history screen.

Voice recognition

- Press this button to switch from the infotainment system screen to the voice recognition screen.
- Press this button again to record a voice command.

Instrument/Back

- In non-instrument cluster menu mode, press this button to display the instrument cluster menu.
- In instrument cluster menu mode, press this button to return to the upper-level screen, or to exit the menu if there is no upper-level screen.
- On the Bluetooth call screen, press this button to end the call.

Mode

- Selecting a mode: press this button to switch among the multimedia app, peripherals, and pre-installed third-party audio/video apps.
 - If speakers are turned off, press this button to turn them on and enter the memory playback mode, or switch to the radio mode if there is no playback source (for example, no external audio equipment) in the memory playback mode.

Horn

- Press this button to honk the horn.



CAUTION

- Avoid pressing honking for too long, as the horn may be damaged.



REMINDER

- Observe the traffic laws and use the horn reasonably.

Steering Wheel Manual Adjustment

To adjust steering wheel angle:

- Press the steering wheel adjustment handle, move the steering wheel to the desired angle, or adjust it to the desired axial position, and restore the handle to the locked position.



⚠ WARNING

- Never adjust the steering wheel while driving, under risk of impaired vehicle control.
- After adjusting the steering wheel, make sure it is securely locked.

Power-Assisted Steering Mode Settings

- Steering feel and requirements vary from person to person.
- Tap on → Vehicle Settings → Driving Comfort Adjustment on the center console touchscreen to go to the Steering Assist screen, and select the Comfort or Sport mode.

! REMINDER

- If steering feels light when driving at high speeds, set the power-assisted steering mode to the Sport mode.

Switches

Light Switches

Rotate the rotary knob to to turn off all lights except DRLs.

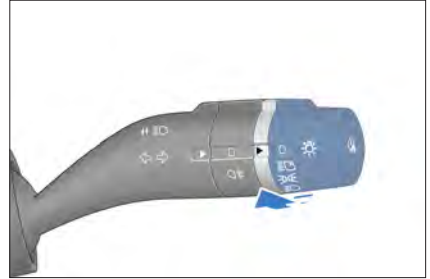

Auto light

When the rotary knob is rotated to , BCM collects the luminance value from the light intensity sensor to automatically turn on or off small lights and low beam.

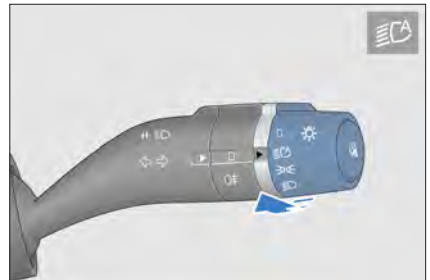

⚠ CAUTION

- The light intensity sensor is located at the top of the dashboard panel. Do not block the sensor or let anything splash on it.

Small lights

Rotate the knob to  to turn on small lights. (They include the daytime running lights, rear sidelights, rear license plate lamp, dashboard background light, small light indicator and some backlights.)

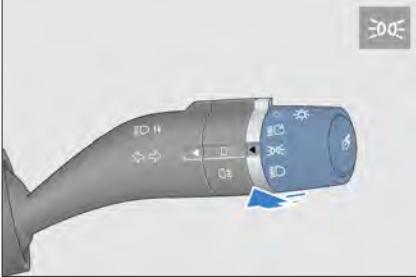

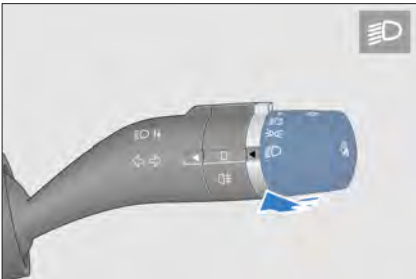

Low beam

Rotate the knob to  to turn on low beam.



Rear fog lamp

Rotate the knob to  and fog lamp switch to  to turn on fog lamps.

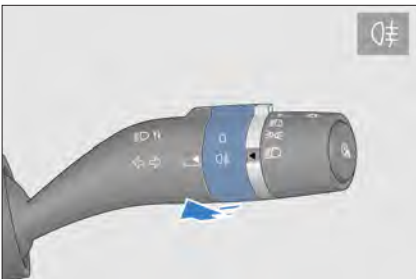

High beam

Rotate the knob to  and push the light handle of the combination switch from the normal position forward (away from the steering wheel). After the handle is restored to the initial position, high beam is activated and the high beam indicator lights up on the cluster. Pull back the light handle, turn off low beam, or exit OK status to deactivate high beam.

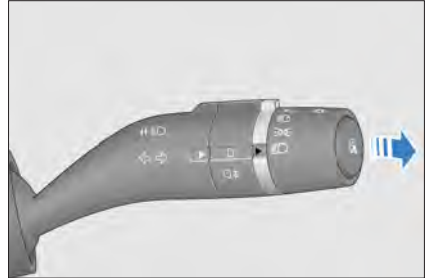

Overtaking lamp

Pull back the light handle towards the steering wheel to activate the overtaking lamp. Release it to deactivate.

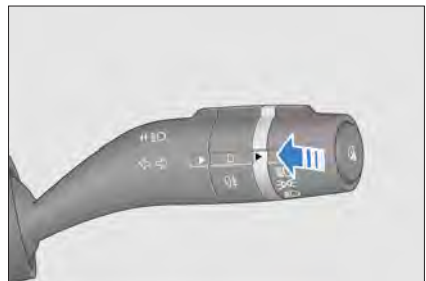

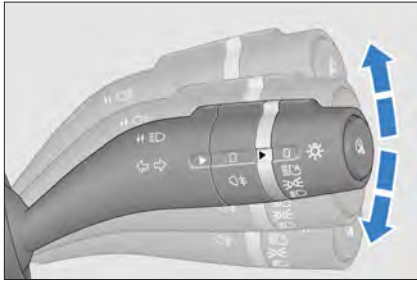

Turning lights

- Pull up the light handle to signal left turn.
- Pull down the handle to signal right turn.









Auto light off

- Conditions for enabling the auto light off function: when the light button on the multifunctional switch is toggled to "  " or "  ", the power supply is switched from "Start" to "Stop" status, and this function is enabled.
- With auto light off enabled, when the driver's door is closed, headlights and small lights go off after 10 seconds.
- With auto light off enabled, when the driver's door is opened, headlights and small lights go on for 10 minutes.
- If the light status is changed when the auto light off function is activated, the lights will come on in the new status. If the conditions for auto light off are still met, this function will be activated again.
- Disabling of auto light off function: when the vehicle is powered on, the auto light off function will be disabled, and the light knob can be operated normally.
- After the auto light off function turns off the lights, the anti-theft mode will be activated. If the anti-theft function is deactivated, the light will turn on again. If the driver's door is closed, the auto light off function will turn off the lights 10 seconds later. But if the door is open, it will turn off the light 10 minutes later.

Lighting delay

- When the vehicle is powered on, tap on  → **Vehicle settings** → **Light @ ambient** → **Headlight after exit** to set the delay time.



- Go-home lighting delay:
 - Owners can set the go-home light delay time on the touchscreen (10 seconds by default). After pulling the light handle of the combination switch to "  ", "  " or "  ", when the vehicle is powered off and the doors are locked, the lights keep on for 10 seconds (or the set time) to provide a lighting source.
- Leave-home lighting delay:
 - Owners can set the leave-home light delay time on the touchscreen (10 seconds by default). After pulling the light handle of the combination switch to "  ", "  " or "  ", when the doors are unlocked to approach the vehicle, the lights keep on for 10 seconds (or the set time) to provide a lighting source.

High Beam Assist (HMA)

- The HMA system uses a multi-function video controller on the front windscreen to determine current driving conditions and, if necessary, automatically switch between high/low beams.

Tap on  → **DiPilot** → **Driving Assist** to turn on HMA.





Activating HMA

- Rotate the knob of the light switch knob to the  position. When the vehicle speed is above 35 km/h and the light meets conditions, HMA is automatically activated and switches between low and high beam based on the current driving environment.

REMINDER

- When HMA is activated, the high beam assist indicator light on the instrument panel will light up.

Deactivating HMA

- How to deactivate HMA:
 - Rotate the light switch knob to any position except .
 - Tap on  → **DiPilot** → **Driving Assist**, or use the shortcut menu to turn off HMA.
 - Manually activate high beam.

Suppressing HMA

- HMA is suppressed in any of the following cases:
 - The vehicle speed is below 35 km/h.
 - The fog light or turning lights light up, or the vehicle makes a sudden turn.

System Limitations

- HMA may be unexpectedly activated, or fail to activate in the following cases (in such cases, drivers are advised to control the lights manually):
 - There are traffic participants (such as pedestrians and bicycles) with poor lighting, railways or waterways nearby, or wild animals on the road.
 - The front windshield is dirty, covered in mist, or blocked by stickers or decorations.
 - There are strongly reflective objects around, such as traffic signs on highways, and water reflection on the road surface.

CAUTION

- When the vehicle collision or sensors have been reinstalled, contact a BYD authorized dealer or service provider to calibrate the sensors, so as to avoid affecting system performance.

Adjust Headlight Height

When the low beam is on, tap on  → **Vehicle Settings** → **Light @ ambient** → **Adjust headlights** on the center console touchscreen to adjust the headlights vertical beam angle.







Vehicle Loading Conditions	Recommended Headlight Height Adjustment Level
One person in the driver seat	0~2
The driver, plus one passenger in the front seat	
All the seats occupied	0~2
All the seats occupied, plus an evenly distributed load (calculated based on the technically permissible maximum laden) in the trunk	1~3
Driver, plus an evenly distributed load (calculated based on the technically permissible maximum laden) in the trunk	1~3

- The advised adjustments may differ in other vehicle loading conditions. Intermediate adjustments can be chosen.

Wiper Switches

Front Windshield Wipers and Washer

- The wiper control stick has five modes:
 -  : High-speed mode
 -  : Low-speed mode
 -  : Intermittent mode
 -  : Stop
 -  : Point wiping mode

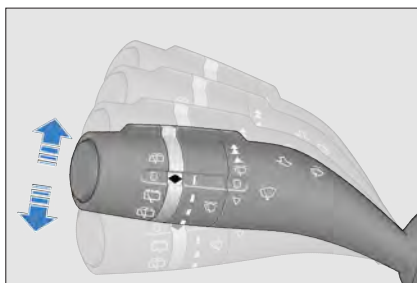

- Push up or pull down the stick to select a mode.
- Pulling down the stick from the " ▽ " position activates point wiping mode, which wipes at low speed as long as it is kept pulled down. Once released, it returns to the " □ " position.
- The " ▽ " INT knob determines the frequency at which the intermittent mode wipes.

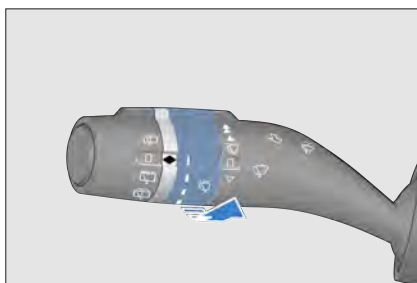

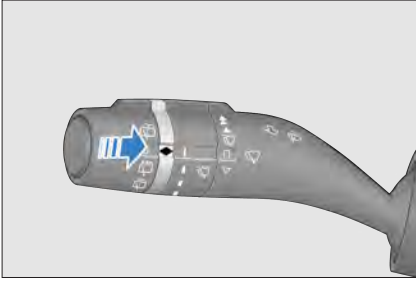

Front windshield washer

1. The front windshield washer spray and wiper are activated when the stick is pulled back towards the steering wheel.
2. The washer spray stops when the stick is released, or when it is held for over 10 seconds. The wipers operate once or twice further after the spray has stopped, and once more after 5 seconds to remove excess water.



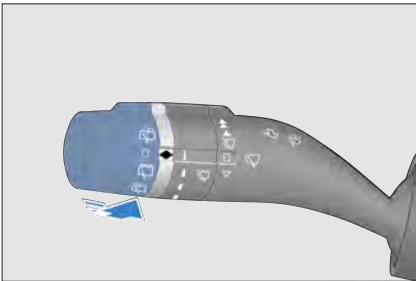

Rear Windshield Wiper and Washer

- Rotate the wiper knob to the  position to start the rear windshield wiper. Rotate the wiper knob to the  position or open the trunk to stop the wiper.

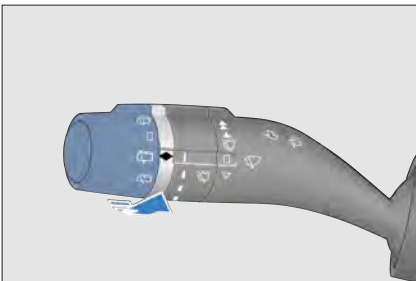

- When the knob is rotated to the  position and held, both wiper and washer start.



- When the knob is rotated to the  position and released, the wiper operates once or twice further after the spray has stopped.

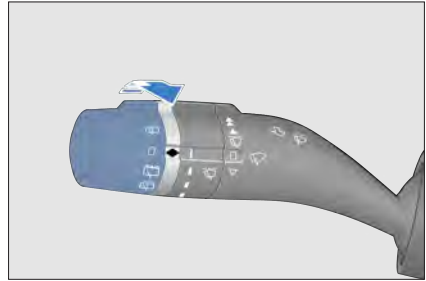

Link between rear wiper and trunk

- The wiper/washer won't work with the trunk opened and the vehicle powered on. If the wiper is working and the trunk is opened, it will stop and resume operation 5 seconds after the trunk is closed. If the front wiper is operating and the gear is shifted to "R", the rear wiper will be automatically activated.

CAUTION

- Do not operate the washer for over 10 seconds, or when the washer fluid tank is empty, as those may cause motor overheating or damage.

REMINDER

- Clean the wipers regularly.
- Avoid using the wipers just as it starts raining. Accumulated dust on the windshield will impair visibility and the proper functioning of the wipers. Do let some rainfall wash some of the dust off before using the wipers.
- Fill the washer tank with suitable washer fluid. Plain water or other types of detergent may damage the washer motor.

Front Door Switches

Electric Windows

- When ignition status is on OK, the window control switch can be used to roll windows up or down. The switches do not work when ignition status is OFF.
- There are control switches for all 4 windows on the driver's door.
 - Press the switch to roll down.
 - Pull the switch to roll up.
- While using the switch, release it to stop window halfway.

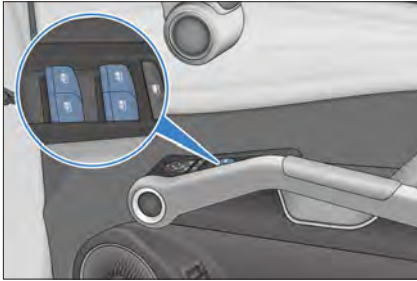

- To roll the window all the way down, press the switch to the second notch and release.
- To roll the window all the way up, pull the switch to the second notch and release.
- Press or pull the switch to stop its motion.

Delay function*

- Windows can be rolled up or down up to 10 minutes after the vehicle is powered off and no front door has been opened. If a front door is opened, the window switches won't work.

Smart window control function*

- Smart Key: this function can be enabled in the infotainment system (for details, see the infotainment settings). When the remote control key unlock button is pressed and held, the windows will roll down automatically. When the lock button is pressed and held, the windows will roll up automatically. If the button is released while windows are in motion, they will stop.
- Microswitch: this function can be enabled in the infotainment system (for details, see the infotainment settings). When the microswitch is pressed and held while carrying the smart key, the windows will roll down automatically. When the the microswitch is pressed and held again, the windows will roll up automatically. If the microswitch is released while windows are in motion, they will stop.
- If functions are disabled in the infotainment system (for details, see the infotainment settings), and when the switch status is OFF, all windows will roll up when the vehicle is locked.

WARNING

- Be mindful of obstructions when the windows are rolling up, specially hands and fingers.

Anti-Pinch Function

Anti-Pinch Function

If there is an obstacle to the window when it is rolling up, it will stop and roll down automatically.

Enabling anti-pinch function

- If the 12 V battery is disconnected while a window is being rolled up or down, the automatic roll-up and anti-pinch functions of windows do not take effect.
- Close the window, release the switch, then operate the switch and hold it for at least 3 seconds.

WARNING

To avoid serious injury or even death, observe the following precautions when closing the windows:

- When controlling the windows, make sure no body part is obstructing the motion.
- Never allow children to use the electric window switches.

CAUTION

- Frequent initialization of the anti-pinch function will trigger the thermal protection function of the elevator motor.
- Never activate the anti-pinch function with a body part.
- The anti-pinch function may fail right before the window is fully close.
- When the auto raise and anti-pinch functions do not work, contact a BYD authorized dealer or service provider.

Window Lock Button*

- When this button is pressed, the driver's door switches can be used to roll all windows up or down, the front passenger's door switch will work normally, but the rear door switches will be disabled.

- When this button is pressed again, the indicator goes off and the rear door switches can be used normally.

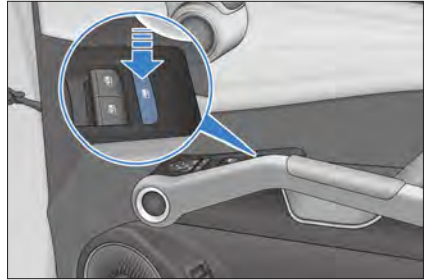

Center Console Door Lock

The driver's door is equipped with an electric door lock. These two buttons can be used to lock/unlock all doors.

(1) Locking

When the center console lock button is pressed, all doors are locked and the red lock indicator lights up.

(2) Unlocking

When the center console lock unbutton is pressed, all doors are unlocked and the red lock indicator goes off.

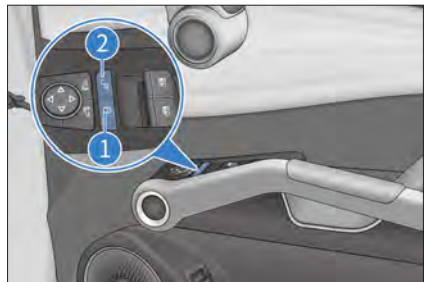

- All doors are automatically unlocked when the vehicle suffers a strong impact.

Trunk Switch

- Pull this switch to open or close the trunk from inside the vehicle.



Odometer Toggle Switch

- Press the odometer toggle switch to select Total Mileage, Mileage 1, and Mileage 2. The odometer displays the switching status accordingly.
- Press this switch to reset mileages 1 and 2.



Driver Assistance Switch Group

The center console also features a Park Assist switch*, BSD switch*, and AVH switch*.

- (1) Park Assist switch

This switch enables the Park Assist function. (For details, see "**Park Assist Power Switch**".)

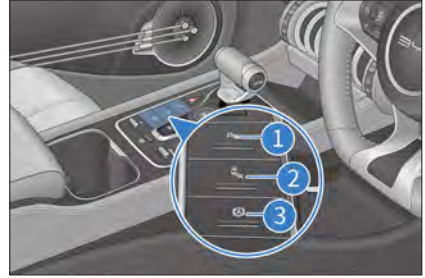

- (2) BSD Switch*

This switch enables the BSD function. (For details, see "**Blind Spot Detection System Setup**".)

- (3) AVH switch*

This switch enables the AVH function. (For details, see "**AVH switch**".)

Window Control Switch on Passenger Side

When the ignition status is on OK, the window control switch on the passenger side can be used to roll windows up or down.

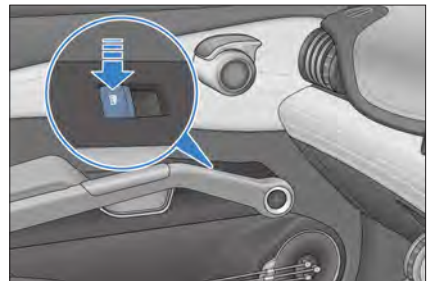

Emergency Warning Light Button

When the Emergency Warning Light Button is pressed, all turning lights and turn signals on the instrument panel start flashing. They all stop flashing when the button is pressed again.

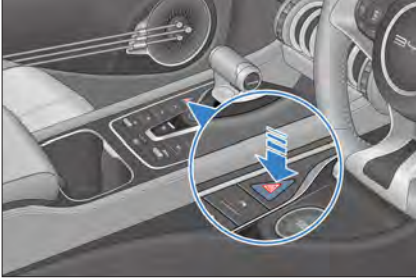

CAUTION

- The emergency warning lights are used to alert drivers and pedestrians of possible risks.

Mode Switch Group

These switches enable drivers to select different regenerative braking, snow, and ECO, SPORT or NORMAL modes.

① Regenerative braking mode

- The default setting is the standard regenerative braking mode.
- Push up this switch to increase regenerative braking.

② Snow mode switch

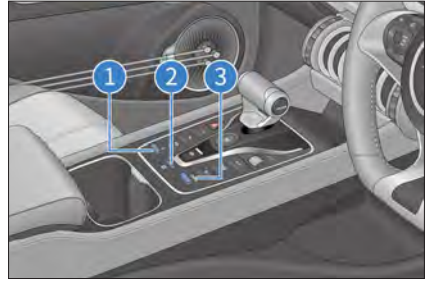

- The vehicle will be exclusively on snow mode when this button is pressed.
 - This mode is recommended when the vehicle is being driven through roads covered in slippery materials such as grass, snow, ice, or gravel.
 - In snow mode, traction and control features are optimized, and the accelerator pedal is selected with caution.

③ MODE switch

- The default setting is ECO mode.
- Move this switch up or down to select ECO, SPORT or NORMAL modes.
- ECO: moderate power, comfortable driving, optimized energy efficiency.
- NORMAL: proper balance between power and energy efficiency.
- SPORT: improved power performance. If battery SOC is too low and vehicle temperature is too high or low, acceleration performance may be lower.

REMINDER

- When the driver switches modes and releases the accelerator pedal, the vehicle's power output characteristics change according to the driver's needs. Make sure to drive safely.
- All modes have a power-off memory function. The vehicle will be in the same mode as it was when it was powered off.

! CAUTION

- In soft snow conditions, if motor performance is worsened due to the dynamic stability control being activated, turning off the ESC system may be useful. ESC must be activated again after conditions are back to normal.

PAB Switch*

- The passenger airbag can be deactivated if the vehicle is equipped with a Passenger Airbag Cut Off Switch.
- The passenger airbag switch is located on the passenger end of the dashboard and is accessible when the passenger door is open.
- Check that the switch is in the required position.



- The front passenger airbag can be enabled or disabled according to the use of the front passenger seat (in case a rear facing child seat is installed):
 - When the switch is ON, the passenger airbag is activated. The PAD status bar will display  . In the event of moderate to severe impact, and the triggering conditions being met, the passenger airbag will deploy.

- When the switch is OFF, the passenger airbag is de-activated. The PAD status bar will display  . In the event of moderate to severe impact, and the triggering conditions being met, the passenger airbag will not deploy.

! WARNING

- Never use a rear-facing child seat on the front passenger seat with an activated passenger airbag.
- The passenger airbag must always be activated when front facing passengers (adults and children above 7 years old) are sitting in the front passenger seat.
- If the recommendations above are not followed, there is a high risk of serious passenger injury or even casualty.

! CAUTION

- To prevent damage to the airbag system, only operate the Passenger Airbag Cut Off Switch when the ignition is OFF.
- It is the driver's responsibility to confirm that the Passenger Airbag Cut Off Switch is in the correct position.

Sunroof Switch

Panoramic Sunroof

The sunroof can only be operated under OK ignition status or when the power-off delay has not expired.

Opening the sunroof

- Press and hold the sunroof open button (1) to open the sunroof. The sunroof stops if the button is released.
- If the sunroof has been initialized, press the sunroof opening button (1) and release it: the sunroof will tilt upward for ventilation. Press again, and the sunroof will automatically open by about 80%. Press one more time, and the sunroof will fully open. If button (1) or (2) is pressed when the sunroof is opening, the sunroof will stop at its current position.

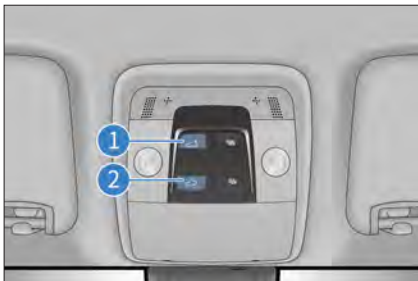

Closing the sunroof

- Press and hold the sunroof close button (2) to close the sunroof. The sunroof stops if the button is released.
- If the sunroof has been initialized, touch the closing button (2) and release it, and the sunroof will close automatically. If button (1) or (2) is pressed when the sunroof is closing, the sunroof will stop at its current position.

Open/Close Sunshade

Opening the sunshade

- Press and hold the sunshade open button (1) to open the sunshade. The sunshade stops if the button is released.
- If the sunshade open button (1) is quickly pressed once, the sunshade opens all the way automatically. If either button (1) or (2) is pressed, the sunshade stops.



Closing the sunshade

- Press and hold the sunshade close switch (2). The sunshade is closed. If you release the switch halfway, the sunshade stops at the current position.
- If the sunshade has been initialized, touch the sunshade closing switch (2) and release it, and the sunshade will close automatically. If button (1) or (2) is pressed when the sunshade is closing, the sunshade will stop at its current position.

! REMINDER

- When the sunroof is not fully closed, the sunshade position will never be further than that of the sunroof.

Sunshade linkage function

- When the sunroof is opened, the sunshade is opened together with the sunroof.

Sunroof Anti-Pinch Function

If the sunroof closing process is obstructed by anything, it will stop and slightly retract.

WARNING

- Keep clear of the sunroof when it is opening or closing.
- Passengers must refrain from sticking hands or their heads out through the sunroof.

CAUTION

- Trying to open the sunroof in outside temperatures below 0°C or when it is covered in snow or frost may damage the sunroof or its motor.

Initialization

- When ignition status is on OK:
- Press the close button once to fully close the sunroof/sunshade.
- If the sunroof/sunshade does not close fully, calibrate manually. Press and hold the sunroof/sunshade close button, and release it when the sunroof/sunshade stops moving. Hold the button again for at least 7 seconds, and release it until the sunroof/sunshade is fully closed and a click sound is heard.
- Initialize the sunroof and sunshade separately.

Interior Light Switches

Front Interior Lights

Left interior light button

Right interior light button

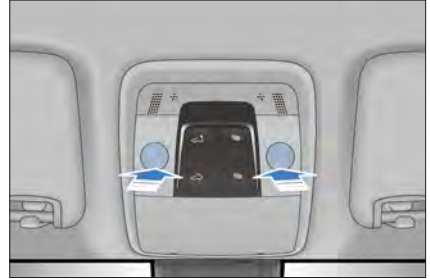

- Press the interior light buttons to turn on left/right interior lights. Press again to turn them off.

Left/Right Rear Interior Light Switched*

- When the ignition status is on OK, press these buttons to turn on the left/right interior lights in the rear cabin. Press again to turn them off.



Ambient Lights

When the door is opened, the intelligent interior ambient lights go on automatically to create a pleasant environment in the cabin.

- Tap on  → **Vehicle settings** → **Light & ambient** to set the following ambient light parameters:
 - Ambient light colour
 - Ambient light brightness
 - Ambient light distribution
 - Music Rhythm

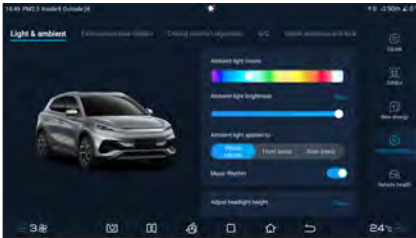

05

USING AND DRIVING

Charging/Discharging	80
Batteries	91
Usage Essentials	95
Starting and Driving.....	101
Driving Assistance Functions	108
Instructions for Other Main Functions.....	131

Charging/ Discharging

Charging Instructions

- The charging equipment is a high-voltage electrical device. Minors are prohibited to charge or touch the charging equipment. In addition, keep minors away from the vehicle when charging.
- Charging may affect medical or implanted electronic devices. Consult the device manufacturer before charging.
- Charge the vehicle in a relatively safe environment, and avoid charging in damp areas, or areas with fine or heat sources.
 - Protect the charging equipment against water contact on rainy days.
- Before charging:
 - Make sure that power supply equipment, charging connector, charge port, and charging connection device are free of defects, such as cable wear, rusted ports, cracked casings, or foreign objects in the ports.
 - Do not charge the vehicle when the charging connector's or port's plug, socket or metal terminals are loose or damaged by rust or corrosion.
 - When the charging connector, port, power plug or socket is visibly stained or damp, wipe them with a dry and clean cloth to ensure the connection is dry and clean.
- Use charging equipment that complies with local standards.
 - Do not modify, disassemble or repair the charging equipment and related ports to avoid charging failure or fire.
 - Do not use charging equipment that does not meet safety standards or has potential safety hazards. Do not allow children to use the charging equipment and keep animals away from the vehicle while charging.
 - Make sure your hands are properly dry before charging.
 - If anything abnormal is found in the vehicle or charging equipment when charging, stop immediately and contact a BYD authorized dealer or service provider.
 - Always observe the following precautions when charging to prevent damage to the vehicle:
 - Do not shake the charging connector, otherwise, the vehicle charge port may be damaged.
 - Whenever possible, do not charge the vehicle during a thunderstorm, under risk of lightning strikes.
 - Do not open the hood for maintenance while charging.
 - After charging, do not disconnect the charging equipment with wet hands or while standing on any wet surface.
 - Before driving, make sure that the charging equipment is disconnected from the charging port.

Compatibility of Vehicle and Charging Infrastructure

- These signs are located on the vehicle's charging socket and charging infrastructure components (charging station, socket).

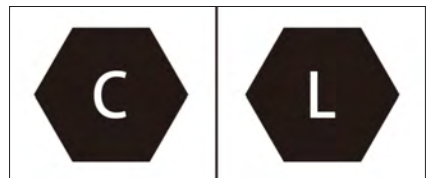

- The signs refer to standardized charging systems in accordance with DIN EN 62196.

Charging Precautions

- When the SOC indicator on the instrument cluster reaches the red warning bar, the SOC is insufficient. Charge immediately. If the vehicle is charged after its power is completely exhausted, the power battery service life may be affected.
- Household AC charging refers to charging using the AC charging connection device the vehicle is equipped with. Use a dedicated AC line and power outlet that meets local standards. The dedicated line can avoid line damage or line tripping caused by the power battery's high-power charging. Failure to use a dedicated line may affect the normal operation of other equipment on the line.
- Avoiding damage to the charging equipment:
 - Prevent the charging equipment from suffering any mechanical impact.
 - Do not place the charging equipment near heaters or other heat sources.
- Inserting charging connectors:
 - Check that the charging connector and port are free of foreign objects, and that the anti-contact cap of the charging connector terminal is not loose or deformed.
 - Hold the charging connector with one hand, align the connector with the port and push it in, making sure that they are properly connected.
- Removing the charging connector:
 - Make sure the port is unlocked when charging is finished or stopped.
 - Pull the connector with one hand.
 - Do not forcibly pull out the charging connector when the port is locked.
- The vehicle can be powered on to use the A/C while charging, however, this is not recommended.
- The vehicle should be parked in a ventilated area, and there should not be any occupant inside when charging.
- When the power battery is fully charged, the system automatically stops charging. The charge port is equipped with an electronic lock, therefore, unlock it before removing the charging connector.
- When DC charging stops, disconnect the charging equipment first, and then the charging connector. In household AC charging, remove the vehicle connector first, and then the power supply connector.
- When charging is completed and the connector removed, make sure the port cover is reinserted and port hatch closed.
- Before starting the vehicle, check that the charging equipment has been disconnected. The charging equipment locking mechanism can be triggered when the charging connector is not properly inserted. If the vehicle is started at this time, the charging equipment and the vehicle may be damaged.
- When the battery temperature is too low or too high, the charging performance may be affected.
 - When the battery is charged at low temperatures, the temperature control system can improve the battery's low-temperature charging capacity. It is normal that a limitation in the charging pile output capacity prolongs charging and heating time, and increases heating power consumption.

- During DC charging, low temperatures and high SOC will reduce the charging current due to the battery's low temperature characteristics. Therefore, to improve charging speed, charging with a low SOC is recommended.
- To improve charging performance and user experience, charge the vehicle right after use, to take advantage of the battery's higher temperature.
- Charging and battery control system performance will be affected if the vehicle is charged at low temperatures with the A/C on.
- When the battery temperature control system is working during charging, the SOC displayed on the instrument cluster or infotainment system may fluctuate temporarily.
- Battery balancing is enabled before charging is completed to improve service life. In such case, charging time may be prolonged.
- The use of A/C may worsen battery temperature control system performance in DC charging at high temperatures, resulting in lower charging performance and longer charging time. Turn off A/C to ensure charging efficiency.
- When the heating or cooling function is enabled for charging, both charging time and power consumption will increase.
- To insure optimum battery temperature, the battery cooling system may continue working after charging is completed.
- During charging, the estimated remaining time to full charge is displayed on the instrument cluster or infotainment system. Depending on the temperature, SOC, and charging facilities, the remaining time to full charge may vary slightly. Before charging is completed, "Calculating..." is displayed on the instrument cluster.
- If the vehicle is not expected to be driven for longer periods of time, make sure to fully charge its power battery before use. In case of idle periods, it is recommended that the battery is charged every three months in order to prolong its service life.

REMINDER

- Do not forcibly open the port hatch.
- Do not forcibly insert the connector with the electric lock engaged.
- Do not close the port hatch without reinserting the port cover.
- It is normal that the cooling fan and A/C compressor start working after charging to fulfill power battery heating or cooling requirements.

General Charging Faults and Solutions

Fault	Possible Cause	Solution
Charger is connected, charge starts, but battery will not charge.	Charging card in arrears or faulty charging pile.	Consult card balance or contact charging station staff.
	AC charging connector not properly plugged in.	Ensure the charger switch has come up. Check cable length and connection position.
	Low 12 V battery SOC	Connect the vehicle to another 12 V battery to charge its own 12 V batteries after powering on.
	The local standard socket has no power supply.	Ensure the power supply is under overload protection. Use the corresponding charging power supply, i.e., standard 220 V 50 Hz 10 A single-phase two-pole grounded socket.
	Vehicle or AC charging connector failure	Check for power system fault/failure warning light or message on the instrument cluster. If found, stop charging and contact a BYD authorized dealer or service provider.
	Power battery temperature above or below specification	Warm up or cool down the power battery.
Charging stops halfway.	The power battery has been fully charged.	Charging automatically stops when the power battery is fully charged.
	The charging cable is not properly connected.	Ensure the charging connecting device is properly connected.
	AC supply is interrupted.	Charging will restart automatically a while after AC supply returns to normal. If it doesn't, reinsert the charging connector.
	Power battery temperature is too high.	A power battery overheating warning is displayed on the instrument cluster. Charging stops automatically and restarts after the battery has cooled down.
Charging pile failure.	If the vehicle or charging pile displays a failure message, contact a BYD authorized dealer or service provider.	

Charging Methods

- Before charging:
 - Check charging equipment and port for cracks, wear, rust or obstructions.
 - Make sure connection is tight.
 - Make sure the port is clear of fluids or dirt, and its metal terminals are not rusty or corroded.
- In any of these cases, do not charge, under risk of short circuit or electric shock.

Household Portable AC Charging

- Connect the charging equipment to a socket meeting local standards.
- A household socket meeting local standards must be used in order to avoid line damage or tripping due to high-power charging, which may effect the normal use of other devices.
- This (Mode 2) equipment includes a power plug (complying with local standards), a charging connector, a control box and a charging cable. The plug is connected to the standard power socket, and the connector to the vehicle's charging port.
- Charging time: please refer to the message on the instrument cluster or infotainment system.

CAUTION

- Contact a BYD authorized dealer or service provider, or a BYD authorized technician, to select the appropriate power supply according to the charging equipment requirements.

CAUTION

- The equipment must be properly grounded. In the event of failure or damage to the charging equipment, the grounding cable provides a minimum impedance to circuit discharge and thereby reducing the risk of electric shock.
- The power plug must match a properly installed and grounded power outlet that meets safety standards.

REMINDER

- When charging, the charging cable cannot be placed in a spiral, as this will affect heat dissipation.
- For specific charging precautions please refer to the charging instructions.

WARNING

- For specific charging safety warnings please refer to the charging instructions.
- Maximum ambient temperature: 50°C; store the product in a cool and dry place when not in use.
- When charging, do not place the device in the trunk, under the front of the car or near the tires.
- When using it, avoid it getting rolled over by the vehicle, dropped, or trampled on.
- Never drop the device. Never move it by pulling it directly by its cable. When moving the device, it needs to be handled with care.

! WARNING

- Do not modify, disassemble, or repair the charging equipment and related ports.
- It is not recommended to use any additional wire or adapter/connector. If an additional adapter is really needed, select a suitable wire diameter (≥ 1.5 flat wire), and the adapter/connector parameters must meet the requirements.
- Never use the charging equipment if the household power supply strip cable becomes soft, the charging connector cable is worn out, the insulation layer is cracked, or in case of any other damage.
- Never use the equipment when the charging connector, power plug, or power supply strip is disconnected, broken, or any sign of surface damage.
- In order to prevent port hatch wear, do not repeatedly open and close it.

1. Charging

- Power off the vehicle.
- With the doors unlocked, press the charging port hatch to open.



- Open the hatch and remove the port cover. Make sure the port is not obstructed in any way.

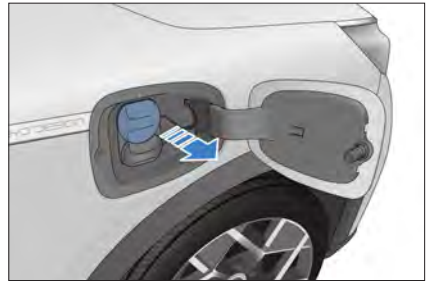

- Insert the Mode 2 plug into the household socket.
- Insert the charging coupler into the charging port.
- The connecting indicator on the instrument cluster or infotainment system lights up.

! CAUTION

- Do not forcibly insert the charging connector when the electric lock is engaged.
- Charging parameters and changes will be displayed on the cluster while charging is taking place.
- At this point, scheduled charging can be set up through Infotainment → 'New Energy' → 'Charge Settings' interface.
- The instrument cluster indicates the estimated remaining time to full charge while charging is taking place. Depending on temperature, SOC, and charging facilities, the remaining time to full charge may vary slightly.
- When the battery is low, the scheduled charging function cannot be used.

2. Stopping charging

- Charging stops when the battery is fully charged.
- To stop earlier, first disconnect the charging port by pressing the door handle microswitch while carrying the smart key and pulling out the charging coupler.

! REMINDER

- To unlock the vehicle, press the key unlock button (OFF when charging) or the door handle microswitch while carrying the smart key.
 - When anti-theft is enabled, unlock the vehicle before pulling out the charging coupler to disable the charging port electric lock. The coupler has to be pulled out within 30 seconds, or the port will re-lock.
 - The electric lock mode can be setup through the  → **New Energy** → **Charge Settings** interface. For setup procedure details, see Charge Port Electric Lock Control function.
 - If the charging coupler cannot be removed after unlocking, a few more unlocking attempts can be tried. If it still cannot be removed, emergency unlocking can be tried. Refer to the charging port emergency unlocking procedure in the lock control.
- Disconnect the power plug.
 - Reinsert the cover and close the port hatch.
 - Store the charging equipment properly.

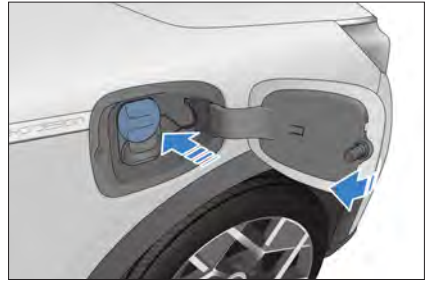

! REMINDER

- If the charging port plug is fully open, do not close the hatch.

! WARNING

- Never drop the Mode 2 equipment. Never move it by pulling it directly by its cable. When moving the device, it needs to be handled with care. Never move it by pulling it directly by its cable.

AC Charging Pile Charging*

1. Equipment description

- Single-phase AC charging box*
 - Use a certified household charging box. For details, refer to the instruction manual and follow the operating steps.
 - Single-phase AC charging box: this equipment includes a charging box, a connector and a connecting cable. For information on circuit breaker and emergency stop switch, refer to the charging box instruction manual.

- Single-phase AC charging pile
- Use AC charging piles in public places to charge the vehicle.
- Charging time: refer to the message on the instrument cluster or infotainment system.

2. Charging operation

- Unlock the vehicle and open the charge port cover:
 - Open as per the instructions for household portable AC charging equipment.
- Connect to vehicle port:
 - Plug the equipment's charging coupler into the port and lock it.
- Setting:
 - For AC charging pile/box subject to authentication, swipe the card or scan the QR code. For details, see the instruction manual for charging pile/box.
- The connection indicator  on the instrument cluster lights up.
- During the charging process, the instrument cluster displays relevant charging parameters and the charging sign.
- At this time, scheduled charging can be set through the infotainment system.

3. Stopping charging

- Stopping charging:
 - Charging stops automatically when the battery is fully charged, or when it is interrupted by the user.
- Disconnecting charging coupler:
 - Disconnect the coupler by following the instructions of the household portable AC charging equipment.

- Close the AC charge port cover (see the portable AC charging process).
- Store the equipment properly.
 - After the AC charging pile/box is used, place the coupler back in its designated position.

Charging Station DC Charging

1. Equipment description

- Use the DC battery charger in public places to charge the vehicle. Generally, it is installed in a specific charging station.
- Equipment specification: see the description of battery charger.
- Charging time: refer to the message on the instrument cluster or infotainment system.

2. Charging operation

- Open the port hatch and remove its cover.

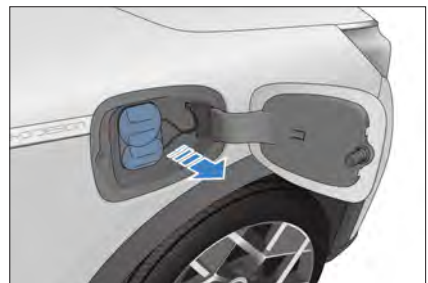

- Plug the coupler into the port, making sure it is tight.
- Operate the charging equipment to start charging.
- The connection indicator  on the instrument cluster lights up.
- During the charging process, the instrument cluster or infotainment system displays relevant charging parameters and the charging sign.

3. Stopping charging

- Stopping charging:
 - When early stop is set or charging has been completed, the charger will automatically stop.
 - Double tap the unlock button within 3 seconds or press the door handle microswitch to stop charging.
- Disconnecting the coupler:
 - Press the door handle microswitch while carrying the smart key and pull out the charging coupler.
- Place the charging coupler in its designated position.
- Reinsert the cover and close the port hatch.

REMINDER

- If the charging port plug is fully open, do not close the charging port cover completely.

CAUTION

- If the charging coupler cannot be removed after unlocking, a few more unlocking attempts can be tried. If it still cannot be removed, emergency unlocking can be tried. Refer to the charging port emergency unlocking procedure in the lock control.
- To unlock during DC charging, press the unlock button twice within 3 seconds for the operation to be successful.
- For specific charging precautions, refer to the charging instructions.

WARNING

- For specific charging safety warnings, refer to the charging instructions.

Smart Charging Function

- When the manager detects that the low voltage battery capacity is low, it can be charged by the power battery, so it is normal that the SOC and driving range displayed decrease when the vehicle is powered on after an idle period.

REMINDER

- When the vehicle lies idle for long periods, it is normal that smart charging takes place.
- Power for smart charging comes from the power battery pack, so it is normal that an SOC decrease is noticed when the vehicle is powered on.

Discharging Equipment*

- This vehicle features a vehicle to load (VTOL) function.

REMINDER

- This function is recommended to be used only when SOC is high.
- This function will be limited when the vehicle is using external discharge or when power is low.
- When ignition status is OFF and VTOL is connected without output for a long time, the vehicle's static power consumption increases. It is recommended that the discharging/charging connectors are removed when the device is not in use.

⚠ CAUTION

- For precautions on the use of discharge connection devices, refer to article 3 of charging precautions, charging precautions for charging equipment.
- Before discharging, confirm the vehicle's power and estimate the remaining driving range.
- Before VTOL discharging, ensure that the load is turned off.

⚠ WARNING

- When discharging, do not touch the discharge power strip, in-car discharge socket, or the metal end of the vehicle's charging port.
- If anything unusual is noticed during discharge, such as smoke or smell, stop it immediately.
- Discharging safety warnings are the same as charging safety warnings (refer to charging instructions).
- Store the product in a cool dry place when not in use.
- When discharging, do not place the device in the trunk, under the front of the car or near the tires.
- When using it, avoid it getting rolled over by the vehicle, dropped, or trampled on.
- Never drop the device. Never move it by pulling it directly by its cable. When moving the device, it needs to be handled with care.
- Never use the discharging equipment if the power supply strip cable becomes soft, the discharging nozzle cable is worn out, the insulation layer is cracked, or in case of any other damage.

⚠ WARNING

- Never use the equipment when the discharging connector or power supply strip is disconnected, broken, or there is any sign of surface damage.

External Discharge

Discharging

- Before discharging, disable the anti-theft function.
- Unlock the charge port cover, and open the cap and the cover.
- Before discharging:
 - Ensure battery capacity is not below 15%.
 - Ensure the VTOL connecting device casing is not cracked, and its plug is free from rust or obstructions.
 - Make sure the port is free from moisture or dirt, and the metal terminals are not damaged and free from rust or corrosion.
 - Do not discharge if any of the above conditions is found.
- Connecting device:
 - Connect the VTOL device to the port. The power strip indicator lights up when the strip is powered and ready for use.

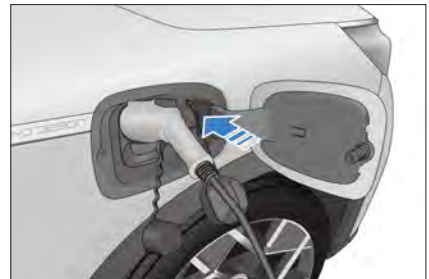

- After the connection is made, discharge begins and respective information is displayed on the instrument cluster.

Stopping discharging

- Stopping discharging
 - Disconnect the load, unplug the connector, reinsert the port cover and close the port hatch (refer to home portable AC charging process*).
- Store the equipment properly.

Charging Port Electric Lock Control Function

- The vehicle's charging port features an anti-theft function during the charging and discharging process. This function is disabled by default. To enable it, go to the charging port lock setting interface by tapping on  → **New energy** → **Charge Settings**, and tap on Enable to turn on the anti-theft function.

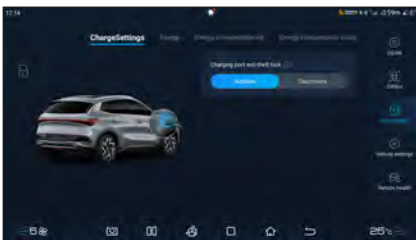

- After it is enabled, users can unlock and pull out the charging connector as follows:
 - When it is OFF, press the smart key unlock button to unlock it;
 - Press the door handle microswitch to unlock;
 - Press the center console lock below the window inside the driver's door to unlock it.

CAUTION

- After unlocking the charging connector, it can be pulled out within 30 seconds. After 30 seconds, it will lock again.

Charging Port Emergency Unlocking

- When the electric lock fails and the charging connector cannot be pulled out, the lock can be manually unlocked by pulling out the charging connector.
- Open the hood and find the inhaul cable, and pull it to unlock the charging connector.

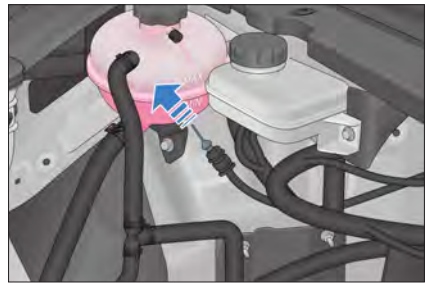

Driving Range Display

- To improve driving experience, the vehicle features a function to select the "Driving Range Display Mode", which is "Standard" by default.
- Set the mode in "Multimedia  → New Energy → Energy Management → Driving Range Display Mode".
 - Standard mode: The driving range is displayed based on the result of the comprehensive working condition test.
 - Dynamic mode: The estimated driving range is displayed based on the available battery power and current average power consumption.

- The set driving range display mode will be memorized by the system.
- When the vehicle is powered off and then on, the display mode set last time will be maintained.

REMINDER

- When the "Dynamic" driving range display mode is set:
 - » The range displayed when the battery is fully charged varies based on the energy consumption of the previous trip.
 - » The driving range actually displayed will be adjusted based on the state of the vehicle's air conditioner, the driving mode (ECO, NORMAL, SPORT, etc.) selected, and the driver's driving habits, so as to match the vehicle's actual driving range.

Energy Regeneration Settings

- Energy is recovered through regenerative braking when the vehicle decelerates. For higher efficiency, do not accelerate or decelerate the vehicle unnecessarily.
- The energy regeneration intensity can be set with the regenerative mode button or the multimedia system.
 - Standard: When the accelerator pedal is released, the motor controller recovers energy in the standard level, and the vehicle deceleration is in the standard level.
 - High: The motor controller recovers more energy when the accelerator pedal is released, and the deceleration of vehicle is high.

- The corresponding settings can be made in "Multimedia  → New Energy → Energy Management → Energy Regeneration Mode".
- Select the regeneration intensity based on the deceleration sense when releasing the accelerator pedal, so as to experience different deceleration senses and have different driving experiences.
- After the energy regeneration intensity is set, it will be memorized. When the vehicle is powered off and then on, the regenerative mode set last time will be maintained.

REMINDER

- Do not set the regeneration intensity when driving the vehicle in high speed, as the driver may be distracted.
- The power of the whole vehicle is weaker at low battery level than that at high battery level.

Batteries

Power Battery

- The vehicle is powered by the power battery. It can be repeatedly charged and discharged. The power battery is charged by external power sources or through energy recovery when the vehicle is breaks or coasts.
- The power battery is located at the bottom of the vehicle, so be careful when driving on uneven or flooded roads.

Battery Properties

- It is normal that vehicle performance is affected by battery electrochemical properties and self-protection. Performance varies in the following conditions:
 - When SOC is high, regenerative braking may decline.
 - Charging switches to trickle mode when SOC is high. If charging time is prolonged, the estimated remaining charging time displayed on the cluster will be different.
 - When SOC is low, acceleration performance may decline.
 - When SOC is low, VTOL* cannot be used. Charge the battery timely.
 - In high or low temperatures, it's normal that the power battery's charging and discharging capabilities decline, and charging time is prolonged. Charging with high-power equipment is recommended to speed up the process. Power performance may also decline under extreme temperatures.
 - When charging in low temperatures, the temperature control system can significantly improve charging capability. For details, see Charging Precautions.
 - When the vehicle is used in low temperatures, the battery's temperature control system will start heating the battery to ensure its power and discharging performance and improve driving experience. When the vehicle is driven short distances, there might be invalid heating, increased power consumption and decreased driving range.
 - When the power battery is normal, the driving range of the vehicle varies according to the following:
 - Driving habit: e.g. frequent acceleration/deceleration instead of uniform speed, or the range is shorter when driving at high speeds than when at low speeds.
 - Road conditions: e.g. range is shorter when driving in rough conditions or on long slopes than when driving in normal conditions and even roads.
 - Temperature: the driving range in low temperatures is shorter than in high temperatures.
 - Electric equipment conditions: e.g. the range driven with A/C on is shorter than that with A/C off.
 - Power battery output is lower in cold weather, and the power available will decrease along with temperature decrease. If the vehicle with high battery level is charged in low temperatures, the SOC may quickly jump to 100%.

Battery Usage Tips

- The vehicle can be driven in temperatures between -10°C to 40°C. When SOC is low, timely charge the vehicle to ensure enough driving range and better acceleration performance.
- To ensure long term performance, avoid driving in extreme temperatures for over 24 hours.
- When temperatures drop, the vehicle can be parked in places where temperatures are higher, such as underground or heated parking areas, to reduce heat loss and ensure vehicle performance.
- Frequent sudden acceleration/ deceleration should be avoided. A/C use increases power consumption and reduces driving range.
- Low-power charging contributes to power battery service life.

- When the vehicle is used for the first time or after a long idle period, the SOC displayed on the cluster may not be correct. Fully charging the vehicle is recommended.
- Fully charging the vehicle is recommended at a regular basis (at least once a week), and fully charge it from a low battery (<10% SOC) once every three to six months.
- Under extreme working conditions (such as frequent sudden acceleration/ deceleration) that cause battery overheating, if the power battery has an over high temperature, it's normal that its discharging capability will gradually decrease. If the battery temperature keeps rising, the fault light on the dashboard will light up. At this time, it is recommended to contact a BYD authorized dealer or service provider.
- When battery SOC increases or decreases abnormally, contact a BYD authorized dealer or service provider.

WARNING

In the event of an emergency or dangerous accident, pay attention to the following:

- Do not touch the power battery under any circumstance.
- Contact a BYD authorized dealer or service provider as soon as possible.
- If the power battery is damaged and leaking fluid, avoid any contact with the fluid. If it comes into contact with skin or eyes, rinse immediately with plenty of water, and seek immediate medical attention.
- If the vehicle catches fire, use the dedicated fire extinguisher to extinguish it. Do not use a water-based fire extinguisher.

CAUTION

- To ensure the safety of the power battery, the vehicle should be parked away from flammable and explosive items, and away from fire sources and all kinds of dangerous chemicals.
- Battery capacity will gradually decrease with time and usage.
- Prolonged exposure to heat sources and direct sunlight will reduce power battery service life.
- If the vehicle is not expected to be driven for over 7 days, it is recommended to keep the SOC at 40 - 60%, as this will prolong battery service life. If the battery is not used for over 3 months, it must be fully charged every 3 months and then discharged to 40 - 60%. Failure to do so may cause the power battery to over-discharge, reducing its performance or even damaging it. Damage resulting from this will not be warranted.
- The power battery is located at the bottom of the car. Drive carefully in rough terrains.
- If the battery suffers an impact, it is recommended to promptly contact a BYD authorized dealer or service provider for inspection and repair.

Power Battery Recycling

How to scrap an NEV:

1. Take the vehicle to the BYD recycling service provider that will assess the residual value of the power battery.
2. Take the assessed vehicle to the recycling organization to disassemble the power battery.
3. Take the battery to the recycling service provider which will buy back the battery.

WARNING

- New energy car owners have the responsibility and obligation to hand over waste power batteries to the recycling service outlet. Those who hand over waste power batteries to other organizations or individuals for dismantling or disassembly without authorization, thus causing environmental pollution or accidents, shall bear the corresponding responsibilities.

Low Voltage Battery (12 V)

Open the hood to find the 2 poles of the lead acid storage battery, i.e. anode ("+") and cathode ("-").

- In order to prevent lead-acid battery low voltage, the "Smart Charging" function will be triggered automatically when: vehicle power supply is "OFF", the power battery is allowed to discharge, and the lead-acid battery level is below a specified value.
- If the battery voltage is very low, it may not be able to power on the vehicle. In this case, contact the BYD authorized dealer or service provider.
- Check the conditions of the lead-acid battery once a month, including corrosion of its poles. If the poles are corroded, disconnect and pour soda water on them. When the bubbles have dissipated, rinse the brown water and wipe them with a dry cloth. Apply some grease to prevent further corrosion.
- If the connector becomes loose, tighten the clamp nut, but do not overtighten it. Tighten just so that the battery is fixed in place. Overtightening will damage the battery box.

REMINDER

- It is normal that when ignition status is OFF during smart charging, there will be a noise similar to that of OK status.
- Do not carry out maintenance work during smart charge.
- When leaving the vehicle, make sure the doors are closed and all electrical equipment is turned off.
- If the vehicle needs to be parked for a long time, please disconnect the cathode wire yourself.

CAUTION

- When checking the lead-acid battery, remove the ground cable from the cathode (-) first, and reconnect it last.
- When cleaning the lead-acid battery, make sure to not let any fluid get inside.

WARNING

- Lead-acid batteries contain a corrosive solution. To prevent damage to the battery or injury, do not disassemble or repair the battery without authorization.
- Do not disassemble or dismantle lead-acid batteries. Any organization or individual to do so shall bear the responsibility for environmental pollution or accidents.
- Lead-acid batteries produce explosive hydrogen gas. When using tools, do not let sparks come into contact with the battery. Do not smoke or use open flames near the lead-acid battery.

WARNING

- Prevent battery fluid from coming into contact with eyes, skin and clothing. In case that happens, use baking soda water to clean the skin, and plenty of water to rinse the eyes, and immediately seek medical attention.
- Avoid mouth contact with the battery fluid.
- Keep children away from lead-acid storage batteries.

Usage Essentials

Break-In Period

- If the power assembly is hard to start or frequently stops running, check the vehicle immediately.
- If the power assembly makes any abnormal noise, stop the vehicle for inspection.
- If the power assembly has serious refrigerant or oil leakage, stop the vehicle for inspection.
- Break-in is a power assembly requirement. This may be done within the first 2,000 km in economic mode. Steady driving instead of high-speed driving is recommended. The following practices can effectively prolong its service life:
 - Avoid flooring the accelerator pedal when starting and driving.
 - Do not maintain high or low speeds for too long.
 - Emergency braking should be avoided within the first 300 km.

Towing Practices

- This vehicle is designed to carry passengers. Do not overload it or use it to tow other vehicles.
- Towing other vehicles will have an adverse impact on the vehicle, including handling, performance, braking, endurance, economic driving or power consumption.
- Driving safety and comfort totally depend on equipment usage and good driving habits.
- BYD doesn't provide free warranty for the damage or faults resulted from towing for commercial purposes.

Driving Safety Precautions

No drunk driving

Even a small amount of alcohol can reduce a driver's ability to respond to changes in traffic conditions. The higher the level of alcohol, the less responsive the driver will be, therefore, drunk driving is strictly prohibited.

No speeding

Speeding is the main cause of collisions and casualties. Generally speaking, the faster the speed, the greater the danger, therefore, maintain a safe speed according to road traffic conditions.

Keeping the vehicle in safe driving condition

Burst tires or mechanical failures are extremely dangerous. Drivers must regularly check vehicle conditions and submit the vehicle to its scheduled inspections to reduce the possibility of such failures.

CAUTION

- Only licensed drivers can drive the vehicle.
- Do not drive when fatigued.
- Traffic laws are to be observed at all times.
- When driving, drivers must stay focused and not carry out any unrelated activity, such as answering calls or adjusting buttons.

Suggestions for Vehicle Use

Battery service life is extended when the following is observed:

- If the vehicle is going to be idle for over 7 days, keep its battery capacity between 40% and 60%.
- If the vehicle is going to be idle for over 3 months, charge the battery fully and discharge it down to 40% to 60%, otherwise the battery will over-discharge, its performance will be jeopardized and damage may incur. Such damage is not covered by the warranty service.
- A 0 (zero) pure electric driving range displayed on the cluster indicates low SOC. In this case, the battery is to be charged immediately to prevent long driving periods with a low SOC battery.
- To keep optimal battery conditions, it should be fully charged with the AC equipment regularly (at least once a week).
- For improved long-term performance, do not expose the vehicle to extreme temperatures (above 60°C or below -30°C) for over 24 hours.

- When there is sunken tray or scratches on the lower surface of the battery pack, go to a BYD authorized dealer or service provider for troubleshooting;
- When the vehicle is traveling, do not repeat rapid acceleration and deceleration;
- When the vehicle is traveling, do not keep it running for a long time as this may lead to over high battery temperature and decline of vehicle performance;
- When the vehicle is traveling, if the fault light is on, go to a BYD authorized dealer or service provider for troubleshooting;
- When the battery temperature is very high, vehicle performance will decline. In this case, keep the vehicle still until the battery temperature decreases.

REMINDER

- If the meter drops to 0, the battery must be recharged. If it is not recharged within 7 days, the battery may suffer permanent damage. Such damage is not covered by BYD warranty terms.
- Driving range depends on a number of factors, such as the vehicle's available power, vehicle age (current battery life), weather, temperature, road conditions and driving habits. Compared with under normal temperatures, the pure-electric driving range is somewhat reduced and power performance will also be affected in low or high temperature environments.

How to Save Energy and Prolong Vehicle Service Life

- Saving energy is simple and easy, and it helps prolong the vehicle's service life.
- Energy and repair cost saving tips:

1. Regenerative braking setting:

- This vehicle can recycle energy. Set the energy through regenerative braking, which can be set by using the corresponding button in the infotainment system. When regenerative braking is set to high, energy recovery increases when braking and coasting. Set this feature according to driving habits.

2. Maintaining constant speed:

- Constant speeds save energy. Sudden acceleration, sharp turns and emergency braking increase consumption.
- Speeds should be kept constant according to traffic conditions. Additional energy is consumed each time the accelerator is pushed.
- Acceleration should be gradual. Avoid sudden acceleration or deceleration.
- Prevent emergency braking, and subsequent brake wear, by keeping an appropriate distance from vehicles ahead, and paying attention to traffic lights.
- Congested roads increase energy consumption.
- Keep moderate speeds in motorways. The higher the speed, the higher the consumption.

3. Reduce load:

- Consumption is higher when air conditioning is used. When outside temperatures are moderate, the use of air circulation instead of air conditioning reduces consumption.
- Do not overload the vehicle unnecessarily.

4. Other tips:

- Make sure tire pressure is correct. Low tire pressure increases energy consumption and wear.
- Keep front wheels properly aligned, avoid driving into curbstones, and drive slowly in rough terrain.
- Keep the bottom of the vehicle clean and mud free.

REMINDER

- Do not coast in neutral gear.

Carrying Luggage

- This vehicle has multiple storage spaces. Overloading or improper placement may affect handling, stability and safety.
- Use the glove box, interior panel and backrest pockets to place small items. Large items are to be placed in the trunk.
- Long items can be loaded by folding the rear seat backrests. Make sure to place loads properly so as not to affect vehicle handling, stability and safety.
- Make sure the vehicle's total load (vehicle + passengers + luggage) remains within the specified maximum weight.

! WARNING

- Overloading and improper accommodation may affect stability and vehicle control, which may lead to accidents.
- Observe the maximum weight limit and other loading guidelines in this manual.
- Do not carry highly magnetic items, for those might interfere in the the vehicle's operating functions.

Carrying Luggage in the Passenger Area

- Items that might injure occupants in case of collision must be properly placed and secured.
- Do not place any item above the rear seats' backrest line so as to keep the driver's rear view clear, and prevent items from being thrown around in case of collision.
- Make sure items do not roll under the driver's seat and reach the pedals or affect seat adjustments. Do not load any item that is taller than the front seat backrests.
- Make sure the glove box is always closed while driving, under risk of severe injury to passengers' knees in case of collision.

! REMINDER

- Be careful with children's toys inside the cabin, for these may pose a hazard in case of emergency braking or accidents.

Loading the Trunk

- Place luggage evenly in the trunk. Place heavier items at the bottom and as far in as possible.
- Secure items with ropes or straps so that they will not move while driving. Do not stack items against the rear seat backrests.
- For trunk strapping or fastening supplies, contact a BYD authorized dealer or service provider.

Flood Precautions

- Check water depth - it must not exceed the vehicle's lower edge - before driving into flooded areas.
- If crossing a flooded area is necessary, turn off the air conditioner and keep acceleration steady to slowly cross over.



- Never stop, back up or turn off the vehicle in flooded areas.
- After crossing over, press the brake pedal several times to dry out the disks and recover brake performance.

WARNING

- The presence of water, mud, or silt in the braking system may delay brake response and extend braking distance. Drive carefully and avoid emergency braking after crossing flooded areas.
- The motor will be seriously damaged if it is submerged when crossing a flooded area. Such damage is not covered by the vehicle's warranty.
- Other systems like transmission, driving and electrical may also be seriously damaged upon submersion. Such damage is not covered by the vehicle's warranty either.

Influence of waterlogging on high-voltage parts:

- If water enters high voltage systems, it cannot fully dry out by any means.
 - Vehicle safety and operating performance will be seriously affected if high voltage parts are waterlogged, because insulation is seriously compromised and the risk of short-circuit is greatly increased.
 - Waterlogged high voltage parts pose a very high safety risk, due to reduced protection and voltage withstanding capacities.
 - Be sure to find a sheltered place when charging the vehicle in rainy weather. After driving through flooded areas, timely contact a BYD authorized dealer or service provider for troubleshooting and processing. Do not drive in flooded areas where water is deeper than half the tire height.
- Do not leave flammable or explosive items in the vehicle.
 - Temperatures may reach 60 to 70 in a vehicle exposed to direct sunlight in summer. Flammable or explosive items like lighters, cleaning products or perfume are not to be left inside the vehicle.
 - Make sure cigarettes are thoroughly put out.
 - Go to a BYD authorized dealer or service provider for regular vehicle checks.
 - Vehicle wiring, connections, harnesses and insulation must be checked regularly. If any problem is found, it must be dealt with promptly.
 - Do not refit vehicle wiring or add any unauthorized electrical appliance.
 - The addition of extra electrical appliances (such as power speakers, lamps, fans, etc.) may overload and overheat the wiring harness and increase the risk of fire.
 - Unqualified refitting of electrical appliances or wiring may increase the risk of fire due to contact resistance and abnormal heating. Do not use fuses which exceed the rated specifications of the electrical appliance, or any other fuse substitute.
 - Avoid exposing the vehicle to direct sunlight for longer periods when parking.
 - Learn how to handle the vehicle's fire extinguisher if you have purchased one.
 - Check the fire extinguisher regularly and replace it upon its expiry date.

Fire Prevention

To timely and effectively prevent vehicle fire, pay attention to the following:

- When the vehicle is being repaired or maintained, make sure the cathode end of the low voltage battery is disconnected.
- In case of fire, keep calm and take the necessary steps to put it out.
 - Pay attention to early signs of fire, like unusual smell or noises. If any abnormality is found, stop immediately, check for fire and use the extinguisher if necessary.
 - Dial (emergency number) to notify the authorities and insurance company.
 - Look for the ignition point. If the cabin smokes, do not open the hood immediately (This will let a large amount of air in and cause fire spreading. There is limited comburent in the cabin. Keeping the hood closed can control the fire so that the fire can be easily put out). Point the on-board fire extinguisher at the ignition point from the hood gap to put the fire out, or seek help from the passing cars. If you can borrow more fire extinguishers, open the hood to put it out when you cannot see any flame from outside.
 - If the fire brigade is involved, ask for a duty performance certificate and a description of fire cause.

 **REMINDER**

- In order to mitigate losses in the event of an accident, the purchase of commercial insurance (fire loss, theft, etc.) is recommended.

Starting and Driving

Starting the Vehicle

In normal cases, start the vehicle as below:

- Engage the parking brake firmly.
- Switch the gearshift lever to P or N.
- Carry a valid smart key.
- Press the power button (2) while pressing the brake pedal (1).

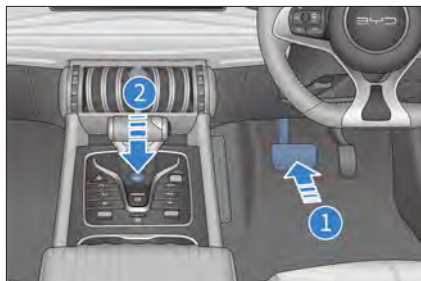

- When the "OK" indicator lights up on the cluster, the vehicle is powered on.

The vehicle cannot power on when:

- The smart key warning light is lit up and there is a "No key detected" message on the cluster, meaning the key is not in range or cannot be detected.
- The key is somewhere unsuitable for detection, such as on the floor, in the cup holder, trunk, etc.

Starting the vehicle in emergencies:

- The parking brake must be engaged.
- Turn off all lights and accessories.
- The electronic smart key is in the vehicle.
- Press and hold the smart key start button for over 15 seconds.

CAUTION

- Do not touch the power button while driving.

Remote Start Function

Before starting the vehicle:

1. The power mode is OFF.
2. The gearshift lever is on "P".

Electronic Smart Key "Remote Start Function"

1. Press and hold the "Remote Start/Stop" button on the electronic smart key for 2 seconds to start the vehicle. After it is started, the turning lights flash three times.
2. If there is no effective operation within 10 seconds after remote start, the vehicle powers off automatically and the turning lights flash twice.
3. Press and hold the "Remote Start/Stop" on the electronic smart key for 2 seconds to power off. The turning lights will flash twice.



Driving

Safety Check before Driving

Carry out a safety check before driving long distances. The vehicle can also be taken to a BYD authorized dealer or service provider for inspection.

Exterior

- Check tire pressure and tires for any damage or anomaly.
- Make sure the wheel nut is firm.
- Make sure headlights and all other lights are working normally.

Interior

- Make sure all seat belts can be properly fastened and are free from any damage.
- Make sure the maintenance indicator, instrument lighting and defroster work normally.
- Make sure there is enough space for the brake pedal to work.
- Check the storage battery connectors for corrosion or loosening, and for cracks in the battery casing.

In the cabin

- Make sure there are fuses of different specifications available.
- Make sure refrigerant level is normal.

Check after starting

- Check the system pipeline for leakage. In case any is found, have it repaired.
- Check that the instrument cluster maintenance indicators and speedometer are working normally.
- Make sure the vehicle maintains a straight direction when the brakes are applied.
- Check for any abnormal noise.

Preparations before Driving

- Check the surroundings before getting into the vehicle.
- Adjust seat position, backrest angle, headrest height, and the steering wheel angle and height.
- Adjust rear view mirror and side mirrors.
- Close all doors.
- Fasten the seat belts.

Gear Shift Controls

- The gear position of the gear actuator is marked on the gearshift lever as shown.
- Press the "P" button to stop the vehicle. Shift to this position when turning the motor on or off.
 - Press the brake pedal and the unlock button to shift gears.



CAUTION

- The "P" gear button must only be pressed after the vehicle has come to a complete stop.
- Reverse gear (R) can only be used after the vehicle stops.
- Shift to "P" whenever leaving the vehicle.
- Shift to "D" for normal driving.

- Before shifting into "D", ensure that the power switch is on "OK".
- Press the pedal or the unlock button when shifting to P or D gear. For details, see the prompt message on the dashboard.
- The lever returns to its middle position after it is released.

! WARNING

- Transmission may be seriously damaged due to lack of lubrication if the vehicle is allowed to move for too long after the motor is turned off and "N" gear is engaged.
- When the motor is running and "R"/"D" gear is engaged, be sure to keep the brake pedal pressed, otherwise the vehicle will move.
- If the gear position is shifted while driving forward, do not step on the accelerator pedal.
- While the vehicle is in motion, do not push the gearshift lever into "R" position or press the "P" button.
- It is not recommended to drive down slopes in "N" or "P" gear, even if the motor is not running.
- To prevent the vehicle from inadvertently moving, engage the parking brake and press the "P" button after the vehicle has stopped.

Electric Parking Brake (EPB)

EPB Switch

- Ensure the EPB is engaged when parking and leaving the vehicle.



Manually Engage EPB

- Pull up the EPB switch, and the EPB will apply an appropriate parking force. The indicator on the instrument cluster (Ⓟ) flashes and then is steady on, indicating that EPB is engaged. In addition, a text prompt "EPB activated" is displayed.

! CAUTION

- Ⓟ When the indicator flashes, EPB is working. If the vehicle is on a slope, do not release the brake pedal unless Ⓟ is steady on, otherwise the vehicle may move down.

Automatic EPB Engagement

EPB automatic engagement

- When the vehicle is turned off, EPB will automatically engage and the "Ⓟ" indicator will light up on the cluster.

"P" gear automatic engagement

- EPB will engage automatically when the vehicle stops and "P" gear is engaged. Do not release the brake pedal until the indicator on the cluster stops flashing and the "EPB engaged" message is displayed.

CAUTION

- If the EPB switch is pressed and shutdown, EPB will not be pop up automatically. This operation can be used for towing or pushing the vehicle in case of breakdown.
- During this process, the brake pedal should not be released in advance, especially when the vehicle is parked on a slope, as there is a risk the vehicle will move down.
- This feature is intended to improve the vehicle's autonomous safety, and over-reliance or frequent use is not recommended. To ensure safety, make sure that the vehicle is set to the "P" gear position or the EPB switch is pulled up before getting out of the vehicle.
- In the first few seconds after starting the vehicle, the EPB system is in the process of power-on self-test, during which it will not respond to all functions.

Manual EPB Release

- When power status is on "OK" or the vehicle is started and the gearshift lever is not on "P"; press and hold the brake pedal and press the EPB switch until the indicator on the cluster is off, which indicates EPB has been released, and there will be an "EPB Released" message.

CAUTION

- The "P" gear is the vehicle's parking gear, meaning that the vehicle is in a stable parking status, while EPB is the vehicle's main parking device. To ensure parking safety, release EPB with the EPB switch only when the vehicle is not in "P" gear (parking gear).

EPB Automatic Release Upon Vehicle Start

- When the vehicle is powered on, the brake pedal is pressed and held, and the gear is shifted into "D" or "R", EPB is automatically released. The indicator goes off and the "EPB released" message is displayed.

CAUTION

- The brake pedal must always be pressed when shifting gears. Release the pedal only after the intended gear is displayed on the cluster.

When the vehicle is in parking state, start the vehicle, press and hold the brake pedal, and shift from "P" or "N" gear into "D", "R" or other driving gears, and EPB will be released automatically, with the indicator  going and the message "EPB Released".



WARNING

- Whenever possible, refrain from using for forced braking. Use the emergency braking function only extreme cases, for example, when the brake pedal fails or is blocked.
- This is because EPB cannot exceed the physical limit of road adhesion. If the emergency braking function is used in curves, dangerous or congested roads, or in bad weather conditions, the vehicle may drift, skid or deviate.

Failure Release Function

- If manual EPB release fails, press the switch for over 2 seconds. If EPB is released, drive the vehicle to the nearest repair shop to check the brake pedal switching signal and relevant parts and lines. If it cannot be released, contact a BYD authorized dealer or service provider immediately.
- When the vehicle is running, the ESC system works normally. If braking is stuck or fails, use CDP (Controller Deceleration Parking) for braking. If only the EPB switch is pulled up, the braking deceleration is 0.4 g; and if the EPB switch is pulled up the brake pedal pressed at the same time, the braking deceleration is 0.8 g. Avoid using EPB for forced braking, but only activate the emergency brake function in case of emergencies such as brake pedal failure or stuck brake pedal.

EPB System Indicator

- When the vehicle is powered on, if the EPB is pulled up, the indicator  on the dashboard will be always on.
- When the vehicle is powered off, if the EPB is pulled up, the indicator  on the dashboard will be off after about 3 seconds.
- When the vehicle is powered on, the EPB system starts self-check. The indicator  will be off after about 3 seconds. If it does not go off, the EPB or braking system may be faulty. In this case, contact a BYD authorized dealer or service provider immediately.

EPB Operating Sound

- When the EPB switch is pulled up or released, the noise of the EPB motor can be heard.
- After the emergency braking function is activated, if there is a burning smell or unusual noises are heard, contact a BYD authorized dealer or service provider immediately.

WARNING

- To prevent the vehicle from moving, the gearshift is not to be used to replace EPB when parking. EPB must be used instead, and the vehicle must be in "P" gear.
- The EPB switch must not be operated when the vehicle is moving.
- When the EPB switch is pulled or released, the brake pedal must be pressed to prevent the vehicle from moving, and the subsequent locking of the gearshift that occurs because EPB cannot provide a sufficient parking force.

Automatic Vehicle Hold (AVH)

Automatic Vehicle Hold (AVH) takes place when the vehicle is stationary for longer periods of time, such as in traffic jams on a slope, or waiting at traffic lights. The AVH function is enabled when the brake pedal is used to stop the vehicle.

- Press the AVH switch to enable AVH. A white indicator for AVH stand-by is displayed on the cluster, and it turns to green when AVH can be enabled.
- Press the AVH switch again to disable AVH.

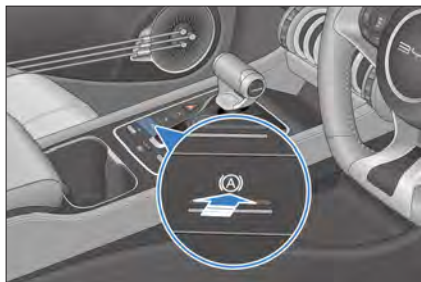

! CAUTION

- When the accelerator pedal is pressed, shift to "P" gear or pull up the EPB switch, the AVH mode will be disabled and the vehicle will return to AVH standby state. If the conditions for AVH standby are not met, and the auto park standby condition is also not met, and the AVH state will also be disabled.

Preconditions for AVH Stand-by (all must be met)

- AVH is turned on and the white AVH stand-by indicator is displayed on the cluster.
- Seat belts are fastened and doors are closed.
- The drive motor is started or ignition status is on "OK".
- Intelligent Power Braking System and Electrical Park Brake (EPB) systems are normal.

! CAUTION

- At power-on, the automatic parking function is disabled by default. It enters stand-by mode, and the instrument panel shows the white AVH stand-by status indicator light.

AVH Running Conditions (all must be met)

- The AVH function is ready.
- In travel gear, the brake pedal is pressed to stop the vehicle.
 - The AVH function is enabled, brake lights go on, and the AVH indicator goes green.
 - The AVH function will enter standby after working for 10 minutes, with the EPB switch automatically popping up.

! CAUTION

- For AVH to be activated, the conditions of the automatic parking function must be met at the same time.
- When the gear is shifted from D to R, the system will enter moving mode, and the AVH function will not be activated. When the AVH button is pressed or after the speed exceeds 10 km/h, the system will exit moving mode.

Low Speed Moving Condition

- When the gear is shifted into "R", the system enters moving mode, and AVH goes into low speed moving mode. When the vehicle reverses at low speed, or gear is shifted into "R" or "D", AVH is suppressed to improve vehicle motion.
- After moving the vehicle, push the AVH switch to exit moving mode, which can also be disabled if the vehicle speed exceeds 10 km/h. Then the AVH function can be activated normally.

Driving Key Notes

- Drive slowly and carefully along gravel roads. To prevent tire damage, do not drive over sharp-edged obstacles.
- Slow down on bumpy or uneven roads.
- Avoid driving through flooded areas as much as possible.
- Slow down when driving against strong winds.
- Drive carefully on slippery roads, such as roads covered in ice, snow or sand; or surfaces like wet ceramic tiles or epoxy resin.

REMINDER

- The battery is located in the vehicle's chassis. Make sure to avoid bumping when driving on rough terrain.
- Before driving, make sure that electronic parking is fully released and that the electronic parking indicator light is off.
- Do not leave the vehicle on "OK" ignition status.
- Remember to carry the smart key when leaving the vehicle.
- Slow down when driving down steep slopes, and avoid braking too frequently to prevent disc overheating, which affects brake performance.
- Be careful when accelerating or braking on slippery roads. Quick acceleration or sudden braking will cause skidding.

REMINDER

- Make sure no occupant sticks their head or hands outside the vehicle, specially when it comes to children.
- Large amounts of water entering the front compartment will cause damage to the power system and electrical components.

WARNING

- Drivers must ensure the safety of all vehicle occupants, and show them how to handle the vehicle's functions properly.

Winter Driving Precautions

1. Make sure the refrigerant is freeze-proof.
 - Use refrigerant of the same type as the one used originally. Fill up refrigerant into the cooling system based on ambient temperature.
 - Improper refrigerant will damage the cooling system.
2. Check batteries and cables conditions.
 - Low voltage battery capacity is lower in cold weather, so they must be fully charged when winter comes.
3. Avoid door frost.
 - Spray some deicing agent or glycerin in the lock hole to prevent freezing.
4. Use anti-freeze washer fluid.
 - These can be found in the BYD authorized dealer or service provider and the auto parts stores.
 - The water and anti-freeze ratio must conform to manufacturer instructions.

CAUTION

- Do not use anti-freeze or other substitutes as washing solution, as this may damage vehicle paint.



5. Prevent ice and snow from going under the splash guard.
 - If ice or snow accumulate under the fenders, steering will be difficult. When driving in cold weather, stop from time to time and check for snow and ice under the fenders.
6. Have emergency tools or items available as prevention for difficult road conditions.
 - It is advisable to have snow chains, window scraper, bags of sand and salt, flashing signal, a shovel and connecting cables in the vehicle.

Driving Assistance Functions

ACC System*

- The Adaptive Cruise Control (ACC) system uses a radar to detect the relative distance and speed of the vehicle ahead, so as to control vehicle speed accordingly. The system switches between regular cruise control and ACC depending on whether there is a vehicle ahead.
- Cruise speed and time interval from the vehicle ahead can be set through the cruise keys. Cruise control speed can be set within a 30 to 150 km/h (20 to 95 mph) range, or a fixed distance can be set from the vehicle ahead for the vehicle to cruise at speeds between 0 and 150 km/h (0~95 mph).

Status description

- ACC off: ACC function disabled.
- ACC stand-by: the system is in stand-by by default when the vehicle is started, and can be manually activated. If the vehicle does not meet the activation conditions, the vehicle must be checked until such conditions are met. The " icon will light up in the cluster after activation.
- ACC activated: the system is operational. It maintains the set speed or automatically adjusts the distance from the vehicle ahead. At this time, the " icon will light up on the cluster.
- Over speed: if the accelerator pedal is pressed with ACC activated, ACC enters over speed mode until the accelerator is released.
- ACC failure: there has been a failure in the system. No operation is carried out, and the " fault indicator lights up.

ACC System Activation Conditions

- EPB is released.
- Vehicle is in "D" gear.
- The vehicle doesn't slide backwards.
- All doors, trunk and bonnet are closed.
- Driver seat belt is fastened.
- ESC system is started, but not activated yet.
- Vehicle speed is under 150 km/h (95 mph).
- Brake pedal is pressed at speed 0; or brake pedal is not pressed at speeds above 0.

- There is no vehicle network communication failure prompt on the dashboard.
- The auto emergency braking function is not activated.

Cruise Button Operation

ACC on/off button

Press the button (1) (when the activation conditions are met, the system will be on stand-by) to turn ACC on/off.

Increase target vehicle speed/ACC reset

Push up the lever (2) to restore to the stored speed prior to exiting the cruise system last time. If no cruise speed is stored, the vehicle travels at current speed.

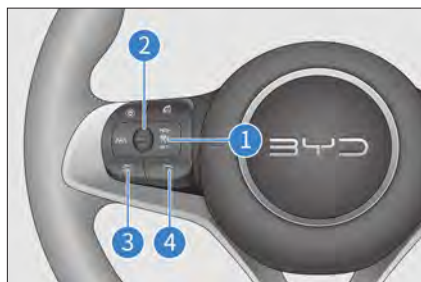

Decrease target vehicle speed/vehicle speed setting

- If the lever (2) is toggled, ACC will set the current speed as the target speed when it is activated from standby. If the current speed is below 30 km/h or 20 mph, the target speed will be set to 30 km/h or 20 mph; and if the current speed is above 150 km/h or 95 mph, the target speed will be set to 150 km/h or 95 mph.

- When the ACC function is active, vehicle speed can be set within a 30~150 km/h (20~95 mph) range, by toggling lever (2). By toggling lever (2) up/down, target speed can be increased/decreased by 5 km/h(mph). When cruise is on standby within the same ignition cycle, the system memorizes the last speed setting.

ACC exit

Pressing the brake pedal will make the ACC system go on stand-by. Press the key (1) again to deactivate the ACC function. A safe vehicle distance must be selected.

Set vehicle distance

- The driver shall select a safe vehicle distance.
- This system adjusts vehicle speed to keep a suitable distance from the vehicle ahead on the same lane. Keys (3) and (4) can be pressed to adjust the four vehicle distance values. For each value, vehicle distance is in direct proportion to vehicle speed. The faster the speed, the longer the distance.

Increase/decrease speed with ACC activated

- When ACC is activated, the accelerator may be pressed so the set target cruise speed is reached. The system will enter over speed mode. If the vehicle is already going at the target cruise speed and the accelerator is pressed, the vehicle will return to target speed after the accelerator is released. If the lever (2) is pulled down while accelerating, the current speed will be reset as the target cruise speed. If the speed goes above 150 km/h, or the accelerator is pressed for over 15 minutes, the system will go on stand-by and the ACC will need to be reactivated.

- When ACC is active and the brake pedal is pressed, ACC will go on stand-by automatically. After the brake is released, ACC needs to be reactivated.

Follow-to-stop/start

- Controlled by ACC, the vehicle can stop when the vehicle ahead stops in normal driving conditions. If the vehicle stops for less than 3 seconds, it can follow the vehicle ahead to start automatically.
- If the vehicle stops for less than 3 minutes, the driver needs to reactivate ACC by pressing the accelerator pedal or using the ACC Cruise button.
- If the vehicle stops for more than 3 minutes, the ACC system will enter standby, with EPB pulled up.

Precautions

- ACC is a comfort system rather than a safety system, obstacle detector or collision warning system. Drivers are fully responsible for keeping control of the vehicle at all times.
- ACC is an ancillary system and does not replace the driver. Drivers are responsible for abiding by traffic rules and keeping vehicle control.
- Traffic flow and weather conditions - such as rain and fog - must be heeded when setting vehicle distance. After the ACC system is properly set, drivers must be able to decelerate until the vehicle stops at any time.
- The ACC system can be activated when driving on expressways and roads in good conditions rather than on complex urban or meandering roads.
- When the ACC system is active and the accelerator or brake pedal is pressed, vehicle control is transferred to the driver, and the ACC system vehicle distance control function will be deactivated.

- ACC can only respond to stationary or slow-moving objects, such as vehicles, the end of traffic, toll booths, bicycles or pedestrians, in very specific conditions.

- For safety reasons, ACC cannot be activated if ESC is not enabled.
- The ACC system cannot identify pedestrians or oncoming vehicles.
- The ACC system can only achieve limited braking instead of emergency braking.
- If the vehicle ahead brakes suddenly (emergency stop), the ACC may not be able to respond, or its response may be slow. In such case, there will be no take over request.
- In some cases, such as when the vehicle ahead is going too slow or too fast, or when the distance is too short, there is no adequate time for the system to decrease the relative speed. In this case, response has to come from the driver. The system does not give any sound or visual warning.
- When reaching or leaving a bend, target selection may be delayed or disturbed. In this case, the vehicle may not brake as expected or may brake late.
- On roads with sharp bends, such as winding roads, the vehicle ahead may be out of ACC sensor detection, which may cause ACC to accelerate.
- A short distance from a vehicle in an adjacent lane may trigger ACC to brake.
- If another vehicle comes behind the target vehicle within ACC detection range, it will immediately be identified as the new target, and prompt a response accordingly, and lead to sudden or late braking.



- In some environments, detection may be affected or delayed. If the target's radar reflection area is too small (motorcycle, etc...), the system may fail to properly detect distance, resulting in late or no response. In such case, vehicle speed must be controlled by the driver. Detection may also be affected or delayed by noise or electromagnetic interference.
- If the target vehicle contact ratio is too small, ACC will not be able to target it, so the driver must keep vehicle control.
- When the vehicle stops as it follows a vehicle ahead, the system will not recognize the end of the vehicle ahead but the lower end of the target (e.g. the axle of a truck with a high chassis or a vehicle bumper) in rare cases, and cannot guarantee proper stopping distance, so that the driver must stay alert and be ready to brake.
- If ACC is activated with the vehicle stationary, the system identifies any stationary obstacle ahead and keeps the vehicle still to ensure a safe startup and prevent collision. This function does not cover all obstacles, so drivers must be alert.
- The radar sensor may be affected by vibration or collision. In this case, contact a BYD authorized dealer or service provider.
- The radar is installed at the front area of the vehicle. If its detection area is blocked, especially by snow, its function may be affected, and the system will exit. The system notifies the exit through HMI. System function recovers after blockage is removed and the vehicle is restarted or runs for a while.
- The radar may have a transient function failure from limited detection if the vehicle runs under special conditions, such as circular ramps or tunnels. The function may be recovered by restarting the vehicle or driving under normal conditions for a while.
- Changing the vehicle structure, such as lowering the chassis or changing the front license mounting plate, may affect the ACC system.
- Metal objects like rail or metal plates used in road construction may interfere with the medium range radar so that it cannot work under normal conditions.
- Do not use the ACC system when visibility is poor, or when driving on slopes, winding roads, or wet roads (covered in ice/snow or flooded).
- In the following cases, go to a BYD authorized dealer or service provider for a medium range radar professional calibration:
 - Front medium range radar or bumper removal.
 - After four-wheel alignment is carried out.
 - Collision.
 - The ACC system performance declines or a system error notification is displayed on the cluster.

Predictive Emergency Braking System

The predictive emergency braking system has two features: Predictive Collision Warning (PCW) and Autonomous Emergency Braking (AEB). This system uses radar and multifunctional video controller to detect with vehicles ahead or pedestrians. When a risk of collision is detected, the system will give a sound alarm and light warning to alert the driver, and improve the potential braking pressure for better response timing. If the system detects increased risk of collision, it will automatically apply braking pressure to assist in collision avoidance or reduce impact.

To enable or disable the PCW function, tap on  → DiPilot → Active Safety. When the vehicle is started, the system is switched on by default.

PCW

- Safety distance warning
 - If the vehicle is too close to the vehicle ahead at speeds above 65 km/h for too long, the system will give a safety distance warning, and the indicator  on the cluster will light up.
- Pre-warning
 - If the system identifies collision risk at speeds between 30 and 150 km/h, there will be a sound alarm and the  indicator will light up on the cluster.
- Emergency warning
 - If the driver fails to respond to the pre-warning, the system will give an emergency alert. The  indicator will flash and there will be a short braking warning.

AEB

- If the driver fails to respond to the emergency warning and the risk level increases, the system will enable the AEB function. The system will engage braking force as much as possible to avoid collision or reduce crash impact.
- If the driver applies insufficient braking force in an emergency, the braking system will provide additional braking force to reach the optimal level required to avoid collision or reduce crash impact.

System Limitations

- In some environments, detection may be affected or delayed. If the target's radar reflection area is too small (e.g. bicycle), the system may not be able to establish its distance, which results in either late response or no response.
- In the following cases, the predictive emergency braking system may be affected or give no response:
 - In rainy, snowy or foggy days, large water splashes, or exposure to direct sunlight or glaring lights.
 - The sensor is dirty, hazy, damaged or blocked.
 - The radar fails under interference from other radar sources, such as strong radar reflection in multi-layered parking areas.
- In complex traffic, the system may not be able to properly respond to the following circumstances:
 - Pedestrians or vehicles moving too quickly within the sensor's detection range.
 - Pedestrians obscured by other objects.
 - Pedestrian outlines are indistinguishable from the background.

- Pedestrian detection fails due to special clothing or other objects.
- Bends with small turning radius.

Precautions

- The predictive emergency braking system cannot ensure zero collision. In complex traffic, the system cannot always clearly identify all the vehicles or pedestrians. It may trigger unnecessary warning or braking action for well covers, iron plates or road signs.
- Make sure to observe surrounding traffic conditions, AEB is not a substitute for normal braking operations.
- Do not overly rely on the predictive emergency braking system as this may result in serious accidents. The system is only an auxiliary safety tool. Drivers must always keep a safe distance from the vehicle ahead, control speed, and be ready to brake or steer away when necessary.
- The AEB system is activated when speed reaches 4 km/h, but it can only reduce vehicle speed when it does not exceed 45 km/h. Careful driving is always required, because the system may not be triggered correctly.
- When the ESC function is disabled or the trouble light is on, the AEB system cannot work normally.
- If the PCW function gives an alarm, the driver must brake based on traffic conditions to decrease vehicle speed or steer away from obstacles.
- If the vehicle travels too close to the vehicle ahead for too long, a safety distance warning will be given. If the vehicle ahead brakes suddenly there is a high risk of collision.
- The system will not trigger AEB when the driver is aware of an emergency warning, but turns the steering wheel, accelerates or brakes.
- The radar sensor may have a transient function failure from limited detection if the vehicle runs under special conditions, such as circular ramps or tunnels. The function may be recovered by restarting the vehicle or driving under normal conditions for a while.
- Sometimes the sensor or multi-functional video controller detect dirt or foreign matter on its surface. In this case, a message will be displayed on the instrument cluster and both PCW and AEB will be disabled. The functions will return after the sensor or camera is cleaned.
- The pedestrian protection function is limited by certain physical conditions and it may not be able to take effect within the 4-60 km/h speed range as required. Drivers must always be aware of their surroundings and use the brakes accordingly. Pedestrian protection warnings and preventive braking depend on the actual situation.
- Pedestrian protection is only an auxiliary tool and does not completely guarantee pedestrian protection. Drivers must always drive carefully.
- Under certain conditions, such as on winding roads, the pedestrian protection function may trigger unnecessary warning or braking.
- In case of system failure due to radar or video controller misalignment, the pedestrian protection function may trigger unnecessary warning or braking.
- The brake pedal becomes harder when AEB is triggered. A large amount of hydraulic pressure pressure will be required to push the caliper in a short time and there will be a sizzling noise.

- The predictive emergency braking system is triggered only when the doors are closed and the seat belt is fastened. In the following circumstances, it will fail to work in the following cases:
 - Any door is not closed or is opened when the vehicle is moving.
 - The seat belt is not fastened or it is unfastened when the vehicle is moving.
 - Hard braking.
 - Hard acceleration.
 - Frequent switching between accelerator and brake pedals.
- System performance may be reduced in the following cases:
 - Strong front bumper impact.
 - Improperly inflated or worn out tires.
 - Unqualified tires installed.
 - Snow chains are installed.
 - Small spare tire or tire repair kit is used.
- In the following cases, go to a BYD authorized dealer or service provider for medium range radar professional calibration:
 - Removal of medium range radar or multifunctional video controller.
 - Toe-in and camber adjustment during four-wheel alignment.
 - Collision.
 - The ACC system deteriorates or becomes abnormal.
- Do not try to test the predictive emergency braking system.

Traffic Sign Recognition System*

- The traffic sign recognition system identifies speed limit signs on the road through multifunctional video controller. When the speed limit icon on the cluster lights up, it means the vehicle speed should be within range.
- This system supports intelligent speed limit warning/intelligent speed limit control function.
- Intelligent speed limit warning: a warning is given when speed exceeds the detected speed limit.
- Intelligent speed limit control: it combines the adaptive cruise function with the speed limit sign recognition function. When activation conditions for this function are met, the instrument will display the message "SET-Activate Intelligent Speed Limit Control". Then the driver activates this function by toggle the lever (2) downward, and the system automatically requests to control the target adaptive cruise speed within the speed limit in a certain period of time.
- Tap on  → **Dipilot** → **Driving Assist** to enable or disable the traffic sign recognition system. When the vehicle starts, the system defaults to the previous settings.



- When the system identifies a speed limit sign, the speed limit icon identified appears (such as ) on the cluster.

- When the cluster shows the speed is over 5 km/h above the identified speed limit, the icon on the cluster flashes to alert the driver. When the system identifies the end of speed limit icon or after the vehicle travels for a while, the speed limit icon disappears.

Precautions

- The speed limit icon disappears within a certain distance after system recognition. The driver must control speed within range.
- The traffic sign recognition system can identify speed limit signs only, and will not control speed.
- In case of lanes with different speed limits, the system identifies the sign of the corresponding lane, and the driver must remain in such lane.
- Weight limit signs not in standard size as per national regulations may mistakenly be identified as speed limit signs.
- If the speed limit sign is unclear or distorted, inclined, reflective, partly covered or overlaid, the camera may be unable to identify the sign completely or clearly.
- The performance of the traffic sign recognition system depends on weather conditions, light and visibility. The system cannot identify signs at night or sunset; in rain, fog, haze, snow or dust; when light is coming from the back of the vehicle, or when there is a sudden change in lighting.
- In case there is a collision, or the camera sensor is reassembled, go to a BYD authorized dealer or service provider for sensor calibration to prevent the system performance from being affected.

Lane Keeping System*

- The lane keeping system (LKS) supports lane departure warning and lane departure prevention functions.
- Lane departure warning detects the lane lines ahead through a multi-functional video controller. When speed is above 60 km/h, the system will notify lane departure with visual, sound and vibration warnings.
- Lane departure prevention provides steering assistance to prevent departure.
- When the Emergency Lane Keeping Assist is activated, the system will provide reverse torque or steering angle to control vehicle steering and help the driver keep the vehicle in its current lane when it is about to depart from a lane (solid/dashed line), in order to prevent it from crossing the edge of the road or colliding with oncoming or overtaking vehicles in the adjacent lanes.
- To enable or disable the LKS, tap on 🗨️ → **Dipilot** → **Driving Assist** → **Lane assist**. When the vehicle starts, the system defaults to the previous settings.
- Warnings include: sound warning only, or steering wheel vibration*, or both*.



Dashboard prompt

After the LKS is enabled, lane boundaries will appear on the instrument cluster.

Lane Boundary

Grey	Function enabled, no lane boundary identified.
Green	Function enabled, lane boundary identified.
Red	Function enabled, vehicle offset when driver does not change lanes. At this time, the vehicle will give a warning according to the setting so that driver can change direction.

System Limitations

- Under complex traffic conditions, LKS may detect incorrect or no lane lines. In the following cases, it may not be able to work or shows poor performance.
 - Poor visibility in snowy, rainy and foggy days.
 - Dirty or fogged windshield, or blocked multi-functional video controller.
 - Glaring from direct sunlight, reflection or oncoming vehicles.
 - Sudden changes in light, such as entering/exiting a tunnel.
 - Faded lane lines.
 - Road boundary with grass, soil or curb cannot be identified.

Precautions

- LKS will be suppressed if turning lights are used or the vehicle changes lanes.
- LKS may be suppressed if lane lines are unclear, too thin, worn, blurred or covered in dirt/snow.



- LKS may be suppressed if the lane is too wide or too narrow; number of lanes increase or decrease; marked lines change suddenly on ramps or exits; or in complex line arrangements.
- LKS may be suppressed when the vehicle travels on slopes or winding roads or too close to the vehicle ahead, or the vehicle ahead blocks lane lines.
- LKS may be suppressed when the vehicle jolts, accelerates or decelerates too quickly, or takes a sharp turn.
- The system operation may be affected if the windshield within the visual field of the multifunctional video controller is cracked, the glass is dyed or inadequately coated; or if there is a reflecting object placed on the dashboard or any other object interfering with camera sight.
- For safety reasons, please do not test the lane departure warning function. The function will be interrupted if any object blocks the multi-functional video controller, or if it is exposed to strong lights. The function returns once conditions return to normal. If it doesn't, contact a BYD authorized dealer or service provider for processing.
- Disabling LKS is recommended in the following circumstances:
 - Driving in sport mode.
 - Driving in bad weather conditions.
 - Driving on uneven roads.

Intelligent Cruise Control System*

- The intelligent cruise control (ICC) system combines ACC with LKS. With the speed range of 0 - 120 km/h (0 - 75 mph), it helps to control the vehicle both longitudinally and transversely to reduce the driving burden and provide a safe and comfortable driving environment.

- When the function is enabled, the driver must always hold the steering wheel and control the vehicle when necessary.
- Users may enable or disable the ICC function by using its switch. When the vehicle starts, the system defaults to the previous settings.



- After the ICC function is enabled, the standby indicator on the cluster lights up: 
- After the ICC function is activated, the activated state its indicator on the cluster lights up: 
- When the ICC function is enabled and the ACC function is activated, and speed is between 0 and 60 km/h:
 1. If lane lines are identified on both sides of the vehicle, it will keep at the center of the lane, regardless of vehicles ahead.
 2. If the vehicle enters a road segment where lines become unclear or absent, and there is a target vehicle ahead, the vehicle will follow it and move slightly from side to side. If there is no target vehicle ahead, the ICC function will be suppressed and only ACC will work.
- When the ICC function is enabled and the ACC function is activated, and speed is between 60 and 120 km/h:
 1. If lane lines are identified on both sides of the vehicle, it will keep at the center of the lane, regardless of vehicles ahead.

2. If the vehicle enters a road segment where lines become unclear or absent, regardless of whether there is a target vehicle ahead, the ICC function will be suppressed and only ACC will work.

CAUTION

- When the system is on, if the driver's hands leave the steering wheel for about 15 seconds, the system will prompt the driver "please take over the steering wheel". If the driver does not take over, it will exit intelligent cruise control mode.
- The intelligent cruise control system is a driving assistance system, not automatic driving. The driver should always maintain control of the vehicle, and his/her hands should not leave the steering wheel for too long. Otherwise, the system will exit after prompting the driver to take control.
- The intelligent cruise control system is affected by the weather, lighting and clarity of lane lines. Performance degrades significantly in situations such as backlighting, sunsets, snow-covered roads, and severely damaged roads.
- The ICC is a system which integrates the functions of the adaptive cruise control system (ACC) and lane keeping system (LKS). Therefore, it is necessary to follow the relevant precautions for ACC and LKS when using it.

Blind Spot Detection System*

The blind spot detection (BSD) system includes the following functions: blind spot detection, lane assist, rear cross traffic alert, rear cross side assist with braking, rear collision warning, and door open warning*. It identifies current traffic conditions through radar sensors so as to remind the driver of safe driving.

How to use

Tap on  → DiPilot → Driving Assist to enable or disable BSD. When the vehicle starts, the system defaults to the previous settings.

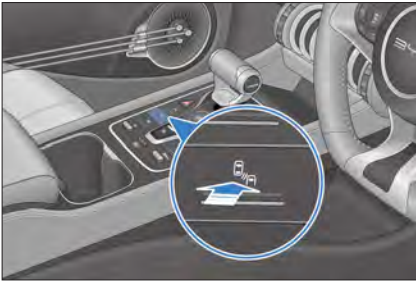

BSD

When speed is above 30 km/h and the sensor detects a vehicle within the blind spot of a side mirror, its alarm indicator lights up. If the turning light for the same side is used at this moment, the alarm indicator flashes to alert the driver of a risky lane change.



Side assist

When speed is above 30 km/h and the sensor detects a vehicle approaching quickly on the adjacent lane, the side mirror indicator lights up. If the turning light for the same side is used at this moment, the alarm indicator flashes to alert the driver of a risky lane change.

Rear cross traffic alert (RCTA)

- RCTA helps the driver check the transverse cross areas on both sides in the back of the vehicle. When the vehicle moves backward, it tells the driver whether there is a vehicle approaching in the back.
- When the vehicle backs up, the RCTA system detects the vehicles traveling in the blind spot in the back through radar. If the RCTA system believes other vehicles approaching in the back may crash into the vehicle, it will turn on the spot indicator on the side mirrors so that the driver can reduce collision risk.

Rear cross traffic brake (RCTB)

- RCTB is used if the vehicle meets another vehicle crossing the road when leaving a vertical/slanted parking space. It will give a warning and help the driver brake to prevent collision, especially when the visual field of the driver is blocked by the vehicle parking beside.
- When the vehicle backs up, the RCTB system receives input from the rear left/right radar sensors and evaluates collision risk and time with the corresponding target.
- Within radar detection range and based on the measured distance to the target, relative speed and approach angle, the RCTB system identifies the level of collision risk, and automatically brakes the vehicle or helps the driver brake manually.

Rear collision warning

If vehicle speed is above 5 km/h and the sensor detects a risk of collision from a vehicle approaching too quickly from the rear, the side mirror light indicator will flash and an alarm will sound to warn both drivers involved.

Door open warning (DOW)*

- The DOW system detects conditions that may endanger vehicle safety from the rear when the vehicle stops and a door is opened, and gives a light warning.
- The rear radar identifies targets within close range from the rear on both sides, detecting risk conditions, and warns the driver accordingly.
 - Detection targets include non-power-driven vehicles like bicycles and other smaller vehicles; as well as other powered vehicles and pedestrians.

CAUTION

- The BSD system assists the driver in monitoring side mirror blind spots, but it cannot replace the driver's subjective observation and judgment. The driver must maintain control of the vehicle at all times, and is fully responsible for the vehicle.
- When a target vehicle is approaching from behind at a high speed, the BSD system may not be able to provide adequate warning.
- The driver should ensure the normal operation of the BSD system, keeping the BSD radar sensors in good condition. For example, if they are covered in dirt, snow or other obstructions, they need to be cleared right away.

CAUTION

- Detection may be affected or delayed in some environments, and when the radar cross-sectional area of the target vehicle is too small (it may be a bicycle, electric moped or pedestrian), the system will not be able to identify risk, leading to false alarms. In addition, detection may be affected by noise or electromagnetic interference, resulting in delays.
- If unrelated targets at the side rear or rear (such as large roadside barriers used during road repair, large advertisement billboards by the road, reflectors in tunnels, or other objects with a large reflection cross-sectional area) are wrongly selected as targets, the BSD system will issue an alert.
- Under some circumstances, it will be difficult for the system to assist the driver and the detection system may be affected or delayed. Possible circumstances include, but are not limited to:
 - » The car coming from the rear suddenly changes lanes;
 - » Sharp turns, slopes and other scenarios may delay target detection;
 - » Relative target speed above 80 km/h;
 - » The target vehicle is obscured;
 - » When the radar reflection cross-sectional area of the target vehicle is too small (it may be a bicycle or electric moped);
 - » The curve radius is too small, or when entering or exiting a curve;
 - » Severe weather, such as rain or snow.

CAUTION

- BSD sensor calibration may be affected by vibration or collision, which will degrade the system's performance. In this case, contact a BYD authorized dealer or service provider.

Tire Pressure Monitoring

System Description

- The tire pressure monitoring system (TPMS) consists of a tire pressure monitoring module, a tire pressure monitoring control module, and a display. It monitors tire pressure in real time and issues visual and sound alarms.
- The system contributes to improving safety and comfort, and reducing abrasion and power consumption.
- Driving and prompt messages are displayed on the cluster. When this is no prompt message, driving messages are displayed. Users may select the tire pressure display interface by pressing  on the steering wheel.
- For standard pressure values, refer to the vehicle parameters in the specification.

Basic functions

- Power-on alarm
 - If tire pressure is low when the vehicle is powered off, a low pressure alarm will prompt the driver to inflate when the vehicle is powered back on.
- Low tire pressure alarm
 - When the system is running, once any of the four tires has a pressure below 75% of the standard tire pressure, the TPMS will give a low tire pressure alarm within 1 minute and indicate tire position;
 - In this case, inflate the tire to the standard pressure. When the tire pressure is above 95% of the standard tire pressure, the alarm stops.
- Fast air leakage alarm
 - When the system is running, once one or more tires leak air at a rate above a specific value, the TPMS will give a fast air leakage alarm within 15 seconds and indicate tire position;
 - In this case, timely check the tires and ensure they are in good conditions prior to driving.
- Fault alarm
 - When the system is running, an alarm will be given if it fails.
- Real time pressure value display
 - When the TPMS is running, the pressure value of each tire is displayed.

Description of alarm display

Tire pressure warning light: 

Alarm	Display Mode	Solution
Low tire pressure	<ol style="list-style-type: none">1. The tire pressure warning lights up.2. The tire pressure value turns yellow.	Check for slow air leakage and inflate the tire to the correct pressure value.
Abnormal signal	<ol style="list-style-type: none">1. The tire pressure warning light flashes and then is steady on.2. The tire pressure value is displayed as: abnormal signal	Check the tire pressure monitoring module, and for any surrounding electromagnetic source nearby.
System failure	<ol style="list-style-type: none">1. The tire pressure warning light flashes and then is steady on.2. Message prompt: check tire pressure monitoring system3. The tire pressure value is displayed as: abnormal signal	Check the tire pressure monitoring module and tire pressure control module, or change them if necessary.

Precautions

- The running time of tire pressure monitoring module is related to the daily travel distance.
- The module regularly transmits information like tire pressure to the display. Therefore, if the tire pressure suddenly declines or there is a flat tire, the monitoring module will not transmit data to the display until the next monitoring. In this case, the vehicle may be out of control. If there is a flat tire and monitoring fails to inform, and the driver feels there is some tire problem, stop driving immediately.
- Improper installation of the tire pressure monitoring module will affect the gas tightness of the tire. The tire pressure monitoring module should be installed and replaced by the professional technicians from a BYD authorized dealer or service provider according to the installation manual.
- To change tire position or replace tire pressure monitoring module, first rematch the entire tire monitoring system. This should be done by the professional technicians from a BYD authorized dealer or service provider; otherwise, system failure may occur.
- Since the tire pressure varies according to external temperature, inflate or deflate the tires according to the value displayed on the dashboard and their standard pressure values.
- The TPMS applies wireless transmission, which may lead to poor reception under serious interference.

WARNING

- If tire pressure is abnormal, the system does not prevent the vehicle from driving. Therefore, each time before driving, the vehicle should be started statically to check whether the tire pressure meets the manufacturer's specified requirements. If not, do not drive the vehicle, under risk of damage or safety risks.
- If pressure is found to be abnormal while driving, check the tire pressure immediately. If the low pressure warning light goes on, avoid sharp turns or hard braking, reduce speed and stop as soon as possible. Driving with low tire pressure can cause permanent tire damage and increase the likelihood of tire scrapping. Serious tire damage may cause serious traffic accidents.

Panoramic View System*

Tap on Vehicle View on the Infotainment home page, press the Steering Wheel button or enter R gear, and the "Panoramic View" will be enabled.



- Landscape mode:
 - Tap on the icons for front, rear, right and left views at the left bottom of the Infotainment screen, and single views will be displayed on the left view area.



- In the single front and rear views, double tap the view area to switch to a 180° perspective and display in full screen.
- Tap the Radar icon  in the Panoramic View to enable the Radar Display and tap it again to disable. When the Radar Display is enabled, an Obstacle warning will be displayed as it is approached.
- Portrait mode:
 - Tap on any two icons for front, rear, right and left views at the bottom of the Infotainment screen, and single views of the selected locations will be displayed in the top and right bottom view area.
 - Slowly tap on the Body Image on the left to switch between visible and invisible body.



- After the vehicle starts, the image before last power-off is displayed on the invisible panoramic screen. Foreign bodies in the underbody and surrounding blind areas may be inconsistent with the actual ones. The underbody image will be updated in real time only after the vehicle has moved, which must be driven beyond its length for a complete update.

WARNING

- This system uses wide-angle fisheye cameras, so the object on the display screen may appear somewhat deformed in comparison with the actual object.
- The panoramic view system is only to be used for parking/driving assistance. It is not safe to park or drive the car relying only on this system, because there are some blind spots in front of and behind the car. The surroundings of the car should be observed in other ways during the parking/driving process, so as to avoid accidents.
- When the side mirrors are not extended in place, do not use the panoramic view system; and when the panoramic view system is used for parking/driving, ensure that all the car doors are closed.
- The distance to an object displayed on the panoramic view screen may be different from the distance perceived subjectively, especially when the object is closer to the vehicle; the driver needs to judge the distance between the vehicle and the object in various ways.

WARNING

- The cameras are mounted on the front bumper, on the lower sides of the left and right side mirrors and above the rear license plate. Make sure the cameras are unobstructed.
- When washing the car body with a high-pressure water gun, try to avoid spraying directly on the cameras, so as not to affect their performance. If there is water or dust on the cameras, it should be promptly wiped clean.
- Protect the cameras from any impact to prevent damage or malfunction.
- If the infotainment system is not fully activated after the vehicle is powered on, and the panoramic view start button or the reverse gear is operated, the output on the panoramic view screen will be delayed or the screen will flash. This is a normal part of the camera power-on process.
- When moving the vehicle at low speeds, as the transparent panoramic function is affected by the speed fluctuation or multiple stops and brakes, there will be a misalignment between the image of the bottom of the vehicle and the image of the outside of the vehicle.

Parking Assistance System

- When the vehicle is being parked, the Parking Assistance system uses sensors to detect obstacles and inform the driver of the distance between the vehicle and the obstacle through the Infotainment screen* and the speaker alarm.
- Parking Assistance is a way to help reverse the vehicle. Make sure to check the vehicle rear and surroundings when reversing.

- When the vehicle goes into reverse, the system automatically enables the Reversing View.
- Never use other buttons under the Reversing View screen, except for volume and telephone related buttons.
- When the vehicle is out of reversing, the screen restores.

Reversing View screen

- The two lines in the image are safety lines for reversing.
 - Red: about 0 m to 0.5 m away;
 - Yellow: about 0.5 m to 1 m away;
 - Green: about 1 m to 3 m away.



- The area shown varies with the vehicle's direction and road conditions.

! WARNING

- When the vehicle speed exceeds 10 km/h, the Park Assist system stops working.
- Make sure the sensors' working range is clear of any object.
- Do not rinse or apply steam to the sensor area when washing the vehicle to prevent sensor malfunction.

Parking Assist Power Switch

- Press the Reversing Radar switch* or tap on Infotainment → Dipilot → Parking Assist → Reversing Radar, to enable or disable Parking Assist.

- When the ignition status is on OK, EPB is released and Parking Assist is enabled automatically.

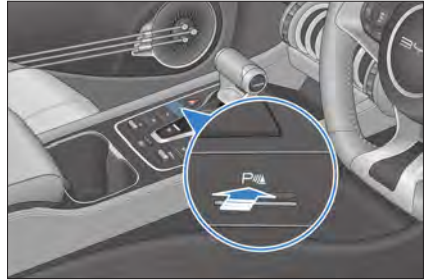

- There is an alarm if obstacles are found surrounding the vehicle when the system is powered on. There is no alarm when the vehicle is powered off.

Sensor Type

- When the sensor detects an obstacle, the corresponding image will be displayed on the Infotainment screen*, depending on the location of the obstacle and its distance from the vehicle.
- The sensor measures the distance between the vehicle and the obstacle when parking or moving the vehicle in a row, and communicates the distance information through the Infotainment screen and the speaker. Be aware of the surroundings for use of this system.





- (1) Front left sensor*
- (2) Front right sensor*

- (3) Rear right sensor*
- (4) (5) Rear right sensor*
- (6) Rear left sensor*



Distance Display and Speaker

When the sensor detects an obstacle, the location of the obstacle and its general distance from the vehicle will be displayed on the Infotainment screen, and the speaker will beep.

Working example of central sensor

General distance (mm)	Infotainment display	Alarm sound
About 700 to 1200		Slow
About 300 to 700		Fast
About 0 to 300		Continuous

Working example of corner sensor

General Distance (mm)	Infotainment Display	Alarm Sound
About 300 to 600		Fast
About 0 to 300		Continuous

Working Sensors and Their Detection Range

All sensors are activated upon reversing.

The figure shows the sensors' detection range. Sensors have a range limitation, so drivers must check the surroundings before slowly reversing the vehicle.



(1) About 1200 mm

(2) About 600 mm

! REMINDER

- Park Assist is designed to assist the driver in parking. It is not a substitute for personal judgment and observation for maneuvering the vehicle.
- Sensors will not work properly if accessories or other objects are placed within their detection range.
- In some cases, the sensor does not work properly and cannot detect objects approached by the vehicle. Therefore, drivers must always observe the vehicle's surrounding area instead of relying solely on the sensor.

Sensor Detection Information

- Certain vehicle conditions and surroundings may affect the sensors' ability to accurately detect obstacles. Detection accuracy may be affected if:

- There is dirt, water or fog on the sensor.
- There is snow or frost on the sensor.
- The sensor is masked in any way.
- The vehicle is significantly rolled or overloaded.
- The vehicle is moving on particularly bumpy roads, slopes, gravel or grass.
- The sensor has been repainted.
- The vicinity is noisy due to honking of vehicles, motorcycle engines, air brakes of large vehicles, or other noises that produce ultrasonic waves.
- There's another Parking Assist nearby.
- The vehicle is fitted with a towing lug.
- The bumper or the sensor was hit hard.
- The vehicle is approaching a high or zigzag curb.
- The vehicle is driving in the sun or in the cold.
- The vehicle is fitted with non-original, lower suspension.
- Except as described above, sensors may not be able to correctly determine the actual distance due to the shape of the object.
- The shape and material of obstacles may prevent sensors from detecting them, especially the following:
 - electric wires, fences, and ropes.
 - cotton, snow and other materials that absorb radio waves.
 - any object with sharp edges and corners.
 - low obstacles.
 - high obstacles facing outwards towards the vehicle.
 - any object under the bumper.

- any object too near the vehicle.
- persons near the vehicle (depending on the type of clothing).
- If an image is displayed on the multimedia display* or there is a beep, the sensor may detect an obstacle or there may be outside interference with the sensor. If such issue persists, go to a BYD authorized dealer or service provider for inspection.

CAUTION

- Do not rinse or apply steam to the sensor area when washing the vehicle to prevent sensor malfunction.

Driving Safety Systems

To improve safety, the following driving safety systems will work automatically based on driving conditions. However, these systems only provide assistance, and excessive driver reliance on them is not recommended.

Intelligent Power Braking System

- Intelligent Power Braking System is an advanced decoupled EHB system, which integrates the functions of vacuum booster, electronic vacuum pump, anti-lock brake system (ABS), electronic stability program and other features.
- Intelligent Power Braking System assists vehicle braking according to the driver's demands. It improves vehicle stability and comfort, as well as recovery efficiency of brake energy.

Vehicle Dynamic Control (VDC)

If the vehicle swerves from the driver's normal lane, the VDC will correct the situation by engaging brakes to the corresponding wheels to help control skidding and maintain directional stability.

Traction Control System (TCS)

TCS prevents the drive wheels from skidding when accelerating, and engages brake control to prevent idling of drive wheels when necessary. TCS makes the vehicle easy to start, accelerate and climb under adverse driving conditions.

WARNING

- TCS effectiveness is affected under the following conditions:
 - » When driving on slippery roads, even if TCS is working properly, it may not be able to control the direction and meet power requirements.
 - » Conditions where stability and power may be lost.

Hill-start Hold Control (HHC)

After the brake pedal is released, HHC maintains brake pressure for 1 second to prevent backward sliding.

Hydraulic Break Assist (HBA)

When the brake pedal is pressed quickly, HBA recognizes that the vehicle is in emergency mode and actively improve the brake pressure so that ABS can intervene more quickly and effectively shorten the brake distance.

Controller Deceleration Parking (CDP)*

When the EPB switch is pulled, the CDP function starts working and the vehicle brakes at a constant deceleration (0.4 g when the EPB is pulled without pressing the brake pedal, and 0.8 g when EPB is pulled with pressing the brake pedal) until the vehicle stops, and it stops working if the EPB is released.

Hill Descent Control (HDC)

Working principle: HDC is a value-added function of the ESC system to improve vehicle comfort, the main function of which is to assist in uphill and downhill slow driving through active braking.

- To enable or disable HDC:
 - Tap on  → **Dipilot** → **Active Safety** → **Hill Descent Control** to enable or disable HDC.
 - The HDC switch can also be pressed when the speed is below 38 km/h. When HDC is enabled, its status indicator on the instrument cluster is steady on.



- Press the HDC switch again to disable the function, and the indicator goes OFF. When the speed exceeds about 65 km/h, the HDC automatically stops.
- When HDC is working, ABS will be activated when the wheel slip exceeds the ABS trigger threshold, allowing the driver to safely and smoothly go downhill, or even reverse.

- HDC speed control:
 - HDC works in speeds between 11 and 38 km/h, within which the speed can be adjusted by pressing/releasing the accelerator or brake pedal, whichever occurs first. The HDC status indicator blinks to indicate that the HDC is working.
- HDC malfunction:
 - In some special conditions, such as at a long stretches downhill, the HDC function may be temporarily unavailable due to high brake temperature.
 - A "Please check the HDC system" will be displayed for safety. To restore the function, stop the vehicle until the brake temperature cools down.
- To enable or disable this function, tap on Infotainment → Vehicle Settings → Drive Comfort Adjust, and go to "Comfort Parking" settings.
- Therefore, increase the distance from the vehicle or obstacle ahead accordingly before stopping.
- Brake Disc Wiping
 - Brake Disc Wiping function: when the wiper switch is on or the rain sensor detects rain, Intelligent Power Braking System applies a small brake pressure to all four brakes so that pads come into contact with discs to remove the water film on the brake disc, and reduce brake response time and shorten brake distance.
 - As long as the system detects rain or wiper ON signal, the brake disc will be repeatedly wiped at certain intervals.

ESC Operation Instructions

Intelligent Power Braking System has the following new functions compared with the original ESC system:

- Brake Pedal Feel
 - It is used to adjust brake pedal feel. Under different modes, the relation curve between the brake pedal depth and the vehicle deceleration is different, and drivers can choose their preferred mode.
 - To adjust the brake pedal feel, tap on Infotainment → Vehicle Settings → Drive Comfort Adjust, go to "Brake Pedal Feel Adjust" settings, and choose "Standard/Comfort".
- Comfort Parking
 - Comfort Parking function: when the vehicle decelerates to stop in a non-emergency situation, Intelligent Power Braking System reduces the stop-instant suspension pitch and impact by controlling the brake pressure of the four brakes, and provides a smooth stop feeling.
- ESC working
 - If there is risk of skidding or backsliding when starting on a slope, or if either drive wheel is idling, the ESC indicator blinks to indicate that it is working.
- ESC deactivated
 - If the vehicle gets stuck in snow or mud, ESC may reduce power output from the motor to the wheels, where the system should be turned off to get out of the jam.
- ESC disabled
 - To disable the ESC, tap on the ESC OFF switch or tap Infotainment System Settings to shut it down. In addition, ESC checks its working status in real time. If the ESC OFF switch is pressed while ESC is working, it completes the active intervention control this time rather than executes the "OFF" command immediately. ESC is disabled only after the intervention control is complete.

- The disabled ESC may be re-enabled if the ESC OFF switch is pressed again or the vehicle speed exceeds the 80 km/h threshold. ESC may be re-enabled only if the ESC is not in a vehicle dynamic intervention state.
- ESC OFF switch mis-operation*
 - ESC is considered to be mis-operated if the ESC OFF switch is pressed for more than 10 seconds. All internal ESC functions will work normally.
- ESC restart after motor OFF
 - After tESC is disabled, restarting the motor will automatically restart ESC.
- ESC start and speed linkage
 - When ESC is disabled, the vehicle becomes extremely unstable as the speed increases and exceeds the 80 km/h threshold, and ESC will start by itself.
- ESC activated
 - If the ESC fault indicator  blinks, drive with caution.
- ESC disabled
 - Be careful when ESC is disabled, and drive at speeds suitable to road conditions. ESC ensures stability and driving force. Never turn it off unless necessary.
- Replacing tires
 - Make sure all tires are the same size, brand, tread and total load. Be sure to inflate tires to the recommended pressure.
 - Neither ABS nor ESC will work properly if the vehicle is fitted with different tires.
 - For details on tire or wheel replacement, contact a BYD authorized dealer or service provider.
- Tire and suspension handling

- The use of any defective tires or modified suspension will affect the driving safety system and may cause the system to fail.

Anti-lock Braking System (ABS)

- The ABS hydraulic system has two separate circuits. Each circuit runs diagonally through the vehicle (the right front wheel brake is connected to the left rear wheel brake). If one circuit fails, two wheels can still be braked.

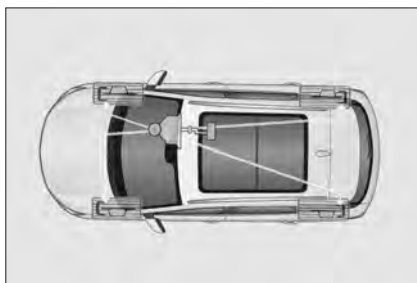

- ABS helps maintain steering control by preventing the wheels from locking or skidding when brake is engaged suddenly or on slippery roads.
- When the front tires skid, there is no steering control, which means that the vehicle still moves forward even though the steering wheel is turned. ABS helps prevent locking and maintain steering control since pulsating prompt brake is much faster than human reaction.
- Never pulsate the brake pedal; otherwise, ABS may malfunction. While steering away from danger, a firm and steady pressure should always be maintained on the brake pedal for the ABS to work. This is what is sometimes referred to as "a firm step and a precise turn".
- When the ABS is working, the brake pedal will vibrate, which may produce noise. This is because the ABS is in pulsating prompt brake, which is normal. How quickly ABS works depends on tire driving force (adhesion).

Important Safety Tips

- ABS does not reduce the time and distance required to brake. It only helps control steering when braking. Always keep a safe distance from other vehicles.
- ABS cannot prevent skidding caused by sudden changes of direction, such as trying to turn a corner or change lanes suddenly. Drive carefully and at a safe speed at all times, regardless of road and weather conditions.
- ABS also does not prevent loss of stability. A large or sharp turn while in motion can cause the vehicle to swerve into oncoming traffic or run off the road.
- Vehicles equipped with ABS may require longer brake distances when driving on soft or uneven surfaces, such as gravel or snow, than vehicles without ABS. In such cases, slow down and keep a long distance from other vehicles.

WARNING

- ABS cannot work effectively under the following conditions:
 - » Insufficient tire grip;
 - » The vehicle skids when driving at high speed on slippery roads.

CAUTION

- If the ABS warning light is still on while the brake system warning light turns on stop the vehicle in a safe place immediately and contact a BYD authorized dealer or service provider.
- ABS cannot prevent skidding caused by sudden changes of direction, such as turning a corner or changing lanes suddenly. Drive carefully and at a safe speed at all times, regardless of road and weather conditions.

CAUTION

- ABS also does not prevent loss of stability. In emergency braking, steer moderately. A large or sharp turn while in motion can cause the vehicle to swerve into oncoming traffic or run off the road.

Acoustic Vehicle Alerting System (AVAS)

AVAS refers to the broadcast to passengers of approaching vehicles when the vehicle is traveling at low speed.

- When driving forward:
 - The broadcast volume increases with increment of velocity that is at $0 \text{ km/h} < V \leq 20 \text{ km/h}$.
 - The broadcast volume decreases with increment of velocity that is at $20 \text{ km/h} < V \leq 30 \text{ km/h}$.
 - The broadcast sound stops automatically when V is greater than 30 km/h .
- When driving in reverse, the vehicle makes a continuous and balanced reminding sound.
- AVAS has two audio modes: standard and dynamic, which give different AVAS sounds and can be switched as desired.

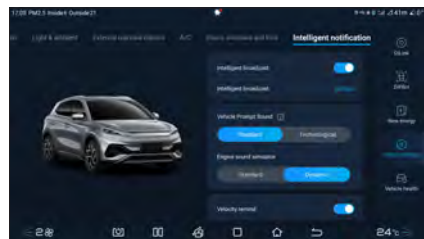

! WARNING

- If the AVAS warning sound cannot be heard when driving at a low speed, stop the vehicle in a relatively safe and quiet place, open the window, then drive at a constant speed of 20 km/h in D gear and listen (maximum volume at this time) to verify the sound effect. If it is confirmed that there is no sound, contact a BYD authorized dealer or service provider to deal with it.

0-100 km/h: Full Throttle Experience

Full throttle can be achieved when:

- The high-voltage battery SOC is 95% or above;
- The vehicle is in SPORT mode.
- Acceleration timer interface is brought up on the information menu.

! WARNING

- Be mindful of all relevant safety measures when experiencing this function.
- Before experiencing this function, check that tires, brakes and other vehicle functions are in optimal conditions.
- Do not use this function when visibility is low.

! WARNING

- Do not use this function on slippery, snowy, muddy, or water-logged roads, nor on grass, sand, etc.
- Do not use this function on roads with complex traffic environments (e.g. at junctions, with pedestrians or other traffic participants).
- Do not use this function before becoming fully familiar with the vehicle, so as to avoid accidents.

Instructions for Other Main Functions

Rear View Mirror

Automatic Anti-Glare Rear View Mirror*

The ECM function automatically adjusts the lens color of the rear view mirror according to the vehicle surroundings to reduce the interference of rear glare on the driver's field of vision.



WARNING

- Do not hang heavy objects from the rear view mirror, or forcefully shake or drag it.
- When manually adjusting the rear view mirror, do not adjust forcibly if it gets stuck.
- Do not adjust the rear view mirror while the vehicle is in motion, as it may distract the driver's attention.

Manual Anti-Glare Rear View Mirror*

- Normal mode - rotate the control stick left to get the clearest mirror image.
- Anti-glare mode - rotate the control stick right to effectively reduce interference from rear vehicle headlights. Note that anti-glare may lower the clarity of rear visual field.



Electronic Side Mirrors

Side Mirror Adjustment Buttons



Manually folding side mirrors

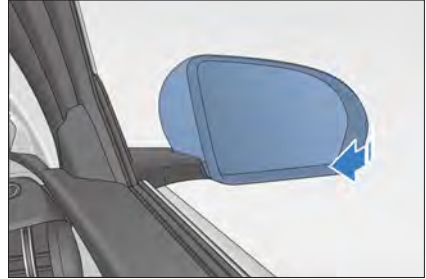

Push the outer edge of the side mirror to rotate the mirror body around the folding axis to the locked position.

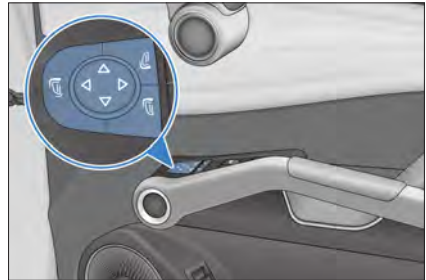

Auto fold of side mirrors



- Press the fold button  to fold both left and right side mirrors, which will return to their pre-folding position if this button is pressed again.
- The left side mirror can be selected by pressing the corresponding auto regulation switch .
- Side mirror auto-fold can be controlled by tapping on  → **Vehicle settings** → **External rearview mirrors** → **Auto-Fold**.

- The right side mirror can be selected by pressing the corresponding auto regulation switch .
- There are four directions  (i.e. up, down, left and right) for regulating lens directions to adjust the side mirrors.

! REMINDER

- If the side mirrors get frozen, do not operate the controller or scrape their surface. Deicing spray should be used.
- Do not adjust the side mirrors while the vehicle is in motion.

Wipers

Replacing Wipers

When the vehicle is powered on, tap on  → **Vehicle health** → **Repair** → **Front wiper check** to enable or disable the front wiper check function. When the corresponding wiper check function is enabled, the wipers rotate out automatically for easy maintenance and replacement.

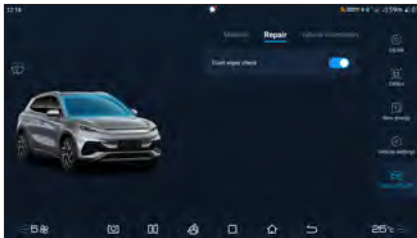

Replacing Front Wipers

1. Pull the wiper arm at the driver side, and then pull the other at the passenger side;
2. Press the Wiper Lock button (1);
3. Hold the wiper blade and pull it out along the indicated direction (2);
4. When installing the new wiper, follow the reverse procedure.

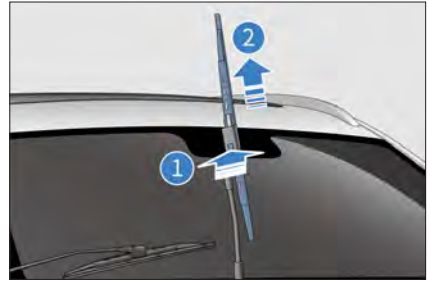

Replacing Rear Wiper

1. Pull up the wiper arm;
2. Hold the wiper in position (1), and pull the blade out vertically along the indicated direction (2);
3. When installing the new wiper, follow the reverse procedure.

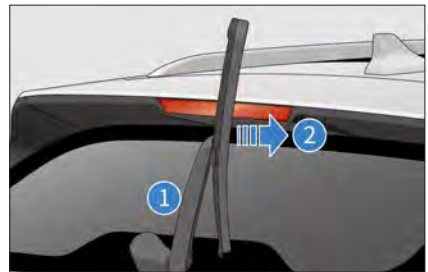

⚠ CAUTION

- Do not open the hood when the wiper arms are pulled up.
- Lower the wipers slowly, avoiding direct impact onto the windshield.
- Do not bend the wiper blade, and do not obstruct the wiper blade when the wiper is in operation.
- When replacing the wiper blade, after raising the wiper arm, hold it steady and gently lower it after replacing the wiper blade. Otherwise, before the wiper blade is installed, any external force could make the wiper arm snap back on the glass and risk breaking it.

Vehicle Travelling Data Recorder*

- To enable or disable the vehicle travelling data recorder (DVR) function, tap on Infotainment → DVR settings. When the vehicle starts, the system defaults to the previous settings.
- DVR consists of three operation interfaces: real-time image, Playback list and Settings, for drivers to query and set driving information. (Please refer to the Electronic Owner's Manual for detailed instructions.)
- The DVR camera is located in the upper middle of the front windshield.



- The lower layer of the auxiliary console is equipped with a special SD card slot for DVR.



DVR View*

Interface description:

- Enter interface:
 - Tap on Driving recorder on the main interface of the center console touchscreen to enter the driving recorder interface.



(1) Function menu bar

- For video recording, taking pictures and video locking

(2) Menu bar

- For selecting real-time image, Playback list, and Settings



Real-time image:

Video recording

- Insert SD card;
- Tap on DVR to enter DVR interface;
- Tap on the red button in the function menu bar to enable video recording, and the system starts to record a real-time vehicle front image video.
- Tap on this button again to disable.
- View the recorded video in the Playback list.

! REMINDER

- If the car is not equipped with an SD card, consult the local BYD authorized dealer or service provider, then purchase the appropriate type and install it.

Taking pictures

- Tap on the Camera on the DVR function menu bar, and the system will take a picture of the vehicle in front and store it in the SD card.

Locking video

- Tap on the Lock button on the function menu bar, and the DVR will lock the first 20 seconds to the next 10 seconds of the video that is currently being recorded.

! REMINDER

- Locked videos will not be overwritten.

Playback list

- Drivers can view recorded driving videos, lock-in videos and pictures taken here.

Settings

- Drivers can set the recording duration, recording resolution, and delete data here.

! CAUTION

- Data deletion cannot be reversed, so carefully consider whether to delete all data beforehand.

06

IN-CAR DEVICES

Air Conditioning System.....	138
Storage	146
Other Devices	147
Infotainment System	151

Air Conditioning System

A/C Panel View

Front A/C buttons:

- ① Auto button
- ② A/C ON/OFF button
- ③ Defrost button for front windshield



A/C Operation Interface

- Tap on → Vehicle settings → A/C to enter the A/C settings interface.



- 1 Fan speed reduction during calls
- 2 Auto air recirculation when parking
- 3 Remote A/C schedule mode
- 4 Auto A/C mode*
- 5 Automatic purification

Setting fan speed reduction during calls

- Tap on this button to enable this setting.
- Tap on this button again to disable it.

Setting auto air recirculation when parking

- Tap on this button to enable this setting.
- Tap on this button again to disable it.

Setting remote A/C schedule mode

- Drivers can select the time for remote A/C schedule.

Setting auto A/C mode

- The A/C mode can be set to economic or comfort mode.

Automatic purification

- Tap on this button to enable auto purification function.
- Tap on this button again to disable it.

Front Row A/C Operation Interface



- | | | | |
|---|--------------------------|----|--|
| 1 | A/C Settings button | 9 | Defrost button for front windshield |
| 2 | Air Purification System* | 10 | Defrost button for rear windshield & side mirrors* |
| 3 | Seat Heating button* | 11 | Internal/external circulation button |
| 4 | A/C Operations button | 12 | Ventilation button |
| 5 | A/C ON/OFF button | 13 | Front passenger A/C temperature regulation button |
| 6 | AUTO Mode button | 14 | Blowing Mode button |
| 7 | A/C Cooling button | 15 | Air amount regulation button |
| 8 | Max Cooling button | 16 | Driver A/C temperature regulation button |

Function Definitions

AUTO Mode button

- After tapping on this button, its indicator lights up on the front A/C panel, and compressor status, air amount and blowing modes can be adjusted automatically.
- The vehicle will exit AUTO control if air amount and blowing modes are set, and other functions will remain in AUTO mode except for the operation function.

A/C ON/OFF button

- Tap on this button to disable the A/C if it is ON.
- Tap on this button to enable the A/C if it is OFF.



Max Cooling button

- Tap on this button to activate the Max Cooling control, and the compressor is started, the temperature is Lo, the air amount is adjusted as Max, the internal circulation is started, and the blowing mode is face level mode.
- Tap on this button again to exit.

A/C Cooling button

- To activate the A/C compressor, tap on this button and the compressor starts to work for cooling.
- Tap on this button again to deactivate the function, and the compressor stops working.

Internal/external circulation button

- Tap on this button, the icon is displayed as , and the air inlet mode will be internal circulation.
- Tap on this button again, the icon is displayed as , and the air inlet mode will be external circulation.

! REMINDER

- When the parking automatic internal circulation is enabled, to ensure air quality in the vehicle and prevent the vehicle exhaust from entering the vehicle, the circulation mode will switch to the internal circulation when parking.

Ventilation button

- Tap on this button to activate A/C ventilation control, and the outlet air will be natural air.
- Tap on this button again to exit.

Temperature regulation

- A/C temperature regulation
 - Tap on the upside arrow or slide it down to increase the temperature. Tap on the downside arrow or slide it up to lower the temperature.
 - When the temperature is set to the lowest, L0 is displayed. When it is set to the highest, HI is displayed.

Defrost button for front windshield

- Tap on this button to activate the front windshield defrosting button indicator on the front A/C panel and enable the front windshield defroster control mode, and the air supply mode is changed to front windshield defroster mode.
- Tap on this button again to deactivate and exit the front windshield defroster control mode.

Defrost button for rear windshield & side mirrors*

- Tap on this button, and the heating panel in side mirrors will quickly clear the side mirrors. It will be automatically disabled after 15 minutes if there are no other commands.

- Tap on this button again to disable the function.
- This function is not to be used to dry raindrops or melt snow.



REMINDER

- Using the side mirror electric heating defrosting function for a long time may cause the mirror to wear out faster. Turn off the defrost button when it is not needed.

CAUTION!

- When cleaning the inside of the rear window, be careful not to scratch or damage the heating wire and the connector.

Air amount regulation button

- A/C air amount regulation
 - Tap on the chosen position, the higher the position, the larger the air amount.
 - Tap on  to set it at position 1, and tap  to set it at position 7.

Blowing Mode button

- Tap on the corresponding icon on the Infotainment system to select the corresponding blowing mode.
- Air blowing modes can be combined freely, and up to three air blowing modes can be enabled simultaneously as required.
- Adjustments can be made according to the following air supply.



Usage Essentials

- To quickly cool down the interior after long exposure to sunlight, drive for a few minutes with the windows open to exhaust hot air and speed up A/C cooling.
- To speed up cooling, adjust the temperature to "Lo" and select the internal circulation mode for a few minutes.
- Make sure that the air intake grille in front of the windshield is not blocked.
- In humid weather, avoid blowing cool air onto the windshield to prevent fogging and reduced visibility.
- Keep the space under the front seats clear to improve air circulation.
- In cold weather, set the air volume to a high range for 1 minute to remove snow or moisture from the intake passage and reduce fogging.
- In cold weather, select internal circulation for a few minutes for quick heating. To prevent fogging after cabin is heated, select external circulation for air intake.
- Drivers should close all windows, set internal circulation mode, and turn on A/C fans when driving in dusty or windy conditions.
- In heating mode, press the compressor control button to light up the button (turning on the compressor), which can reduce airflow moisture.

- In ventilation mode, the system introduces the natural wind from outside, which is suitable for spring and autumn.

! REMINDER

- A/C unpleasant smell:
 - » It is normal that there may be a damp and moldy smell just after the A/C is turned on. That is due to condensation that remains in the evaporator and is not blown dry.
- How to prevent it:
 - » Turn off the A/C and enable natural ventilation before parking to keep the air inside the vehicle relatively dry.
 - » Check, clean or replace the air filter regularly.
 - » Keep the cabin clean.
- If the unpleasant smell persists, contact a BYD authorized dealer or service provider for repair.
- It is normal that the A/C blower keeps running after the vehicle is locked. That is because the condensed water on the surface of the evaporator needs to be dried to prevent mold fermentation.

Vents

Front Center Vent

- Move the knob to adjust airflow or to open/close the vent.
- Toggle left/right to adjust airflow direction.

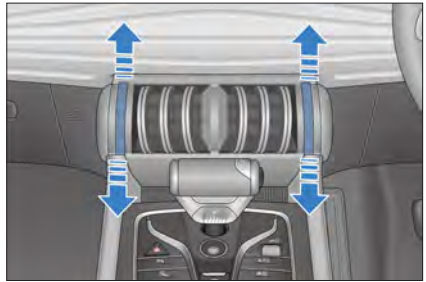

Front Side Vents

- Move the knob to adjust airflow or to open/close the vent.
- Toggle left/right to adjust airflow direction.

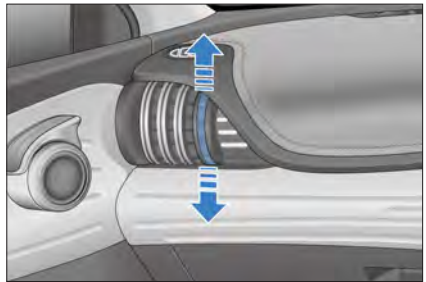

Rear Side Vents

- Move the knob to adjust airflow or to open/close the vent.
- Toggle left/right to adjust airflow direction.

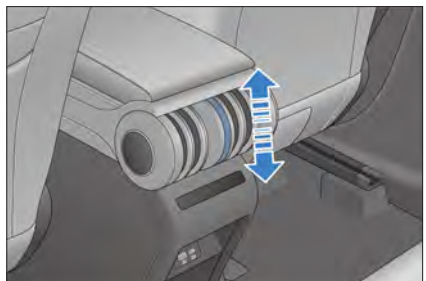

Air Purification System*

When A/C is enabled, the air purification system thoroughly removes PM2.5 particles from the air blown into the cabin.

Air Purification Operation Interface

Tap on the "Air purification" button on the Infotainment operation interface to enter.



- | | | | |
|---|---------------------------------------|---|--|
| 1 | Air Purification Button | 4 | Quick Purification Button |
| 2 | Outside PM2.5 Value and Level Display | 5 | In-vehicle PM2.5 Value and Level Display |
| 3 | PM2.5 Detection Button | | |

PM2.5 Detection Button

- Tap on the "PM2.5 detection" button to activate and detect PM2.5 concentration inside/outside in real-time, which will be displayed in real time on the PAD.
- PM2.5 detection will stop if the button is tapped on again.

Quick Purification Button

- This function can quickly reduce the concentration of PM2.5 particles in the air inside the compartment in a short time.
- Tap on this button to activate and enable the function; and tap on the button again to exit.

In-vehicle PM2.5 Value and Level Display

- It displays the PM2.5 value and level inside the vehicle.
- The PM2.5 value detected by the on-board Air Purification (PM2.5) detector is the PM2.5 value in the air near the vehicle carrying the device in a short time, which should be different from the daily or real-time PM2.5 value of the air published by the state and relevant government authorities.

Here is a reference of air quality grade:

Range of PM2.5 value	Air quality grade
0-35	Good
36-75	Moderate
76-115	Detrimental to sensitive groups
116-150	Unhealthy
151-250	Very unhealthy
251-999	Hazardous

! REMINDER

- The frequency of PM2.5 detection should be reduced in the following environments:
 - » Sandstorms and other such extremely harsh environments;
 - » Cold regions (ambient temperature of <-20°C);
 - » High humidity environments (relative humidity >90%);
 - » Environments with a change in temperature (prone to condensation), such as driving in from a cold environment to a high-temperature indoor environment or parking lot.
- Running maximum air flow speed under internal circulation mode can quickly reduce the concentration of fine particles in the air inside the vehicle.

Switching on A/C with Cloud Service APP

- A/C ON: tap on the "A/C ON" button on the BYD APP control interface, and tap on the "Set temperature", "Duration" and "Circulation mode" buttons for setting, and enter the password to enable A/C remotely.
- A/C OFF: tap on the "A/C OFF" button on the BYD APP control interface, and enter the password to disable A/C remotely.
- A/C schedule: tap on the "A/C schedule" button on the BYD APP control interface, and tap on the "Create Schedule" button, and set time, temperature, duration and circulation mode, and save the settings.

Storage

Door Bins

- There is a door bin on each door for storage of beverage bottles or small items.

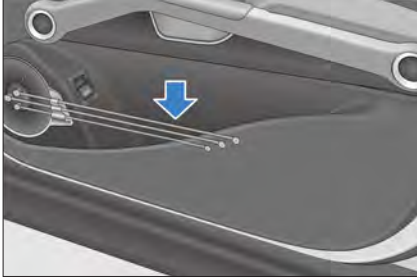

Glove Box

- Pull the handle to open the glove box.
- Push the lid up to close it.

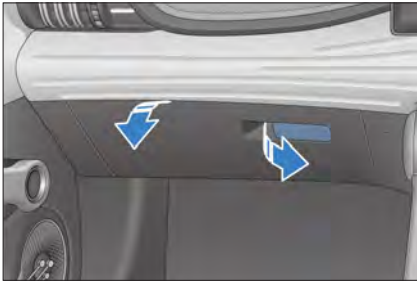

! REMINDER

- To reduce risk of injury in the event of an accident or emergency braking, keep the glove box closed while driving.

Center Console Cubby

- Located between the front seats, open the cover to use.



File Pockets

- There are file pockets on the front seat backrests.

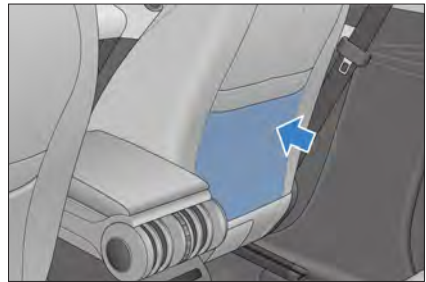

Cup Holder

- The front seat cup holder is located inside the center console cubby.

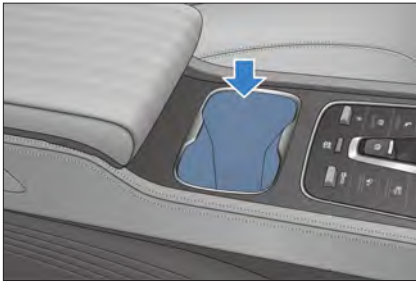

CAUTION!

- Avoid sudden acceleration or braking when the cup holders are being used to prevent spillage.
- Do not place cups without lids in the cup holders.
- To ensure safety, drivers should not use cup holders while driving.

Other Devices

Sun Visors

(1) Sun visor

Sun visors can be used for sunlight coming from the vehicle's front or side. For side use, just pull out the right end and turn it towards the side window.

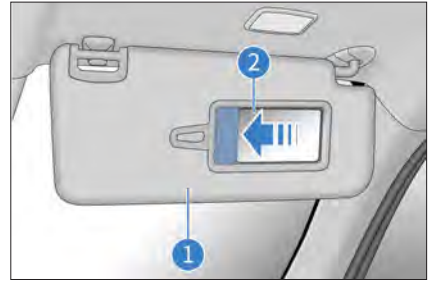

(2) Vanity mirror

- There is a vanity mirror on the inner side of the sun visor. Slide the cover for use.

REMINDER

- Correct use of the sun visor improves driving safety.

Safety Handle

- Pull the safety handle down for use. The handle returns to its original position when released.

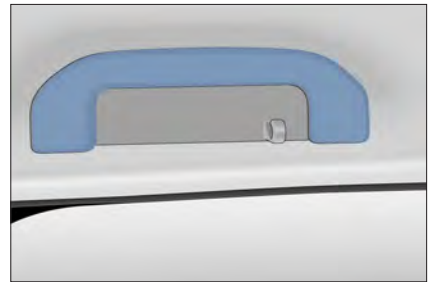

CAUTION!

- Do not hang any heavy objects from the safety handles.

USB Ports

There are two ports installed in the lower layer of the auxiliary console.

- ① Type-A port for data transfer.
- ② Type-C port, which can be used only when ignitions status is on OK.

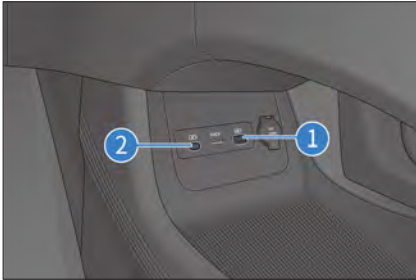

12 V Auxiliary Power Outlet

- It can be used for accessories with 12 V DC working voltage and no more than 10 A working current.
- Lift the cover to use the outlet.

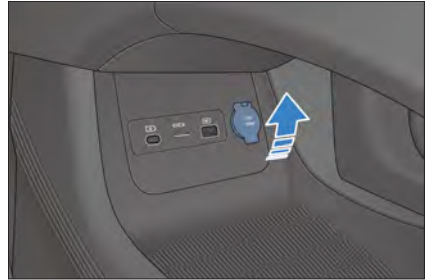

Rear Row USB Ports

- These USB ports are for charging only, and cannot be used for multimedia.
- The vehicle should be powered on before these ports can be used.

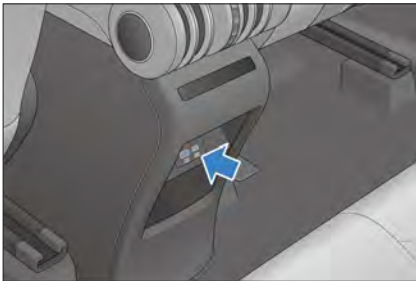

Mobile Phone Wireless Charging Location

- With this feature, phones can be charged without the need of a cable connection.
- Pull down the Infotainment System quick menu to set this function.



- After the vehicle is started, place the phone in the wireless charging area with the screen facing up.

- To disable wireless charger, pull down the PAD quick menu to find the deactivation setting. The indicator will go off.



- The wireless charger only works with Qi certified phones.
- Do not place cards with chips, such as bank cards, between the phone case and the phone during charging to avoid burning the cards.

⚠ CAUTION!

- When the mobile phone wireless charging system is working, ensure that the smart key is more than 25 cm away from the wireless charging area.
- Do not place coins, metal keys, metal rings or other articles containing metal in the wireless charging area with the mobile phone to avoid wireless charging dysfunction or even accidents.
- Do not place heavy objects in the charging area. If the mobile phone charging system breaks down and cannot be used normally, contact a BYD authorized dealer or service provider.

⚠ CAUTION!

- BYD will not assume any responsibility for any problems caused by improper use. If the product is disassembled or modified, the free warranty will be terminated.
- Do not leave unattended phones charging inside the vehicle to avoid potential safety hazards.
- For safety reasons, drivers should refrain from checking phone charging status while driving.
- If a metal item is found between the device and the charger rubber pad while charging, it is not to be removed with bare hands to prevent burning.
- For better charging effectiveness, the center of the phone should be aligned with the center of the charger.
- Prevent any fluid from coming into contact with the charging area.
- Charging may stop in high temperatures, and return once the temperature drops.
- BYD makes no commitments for external wireless charging coil problems. Please use with caution.

! REMINDER

- Only one phone can be charged at a time.
- A phone case that is too thick may prevent charging.
- While driving on bumpy roads, the phone wireless charging system may intermittently stop and resume charging.
- Try to ensure that the phone is placed parallel to the charging module. If the phone moves from the wireless charging area and stops charging, it must be moved back.
- If the phone cannot be charged properly, ensure that there are no foreign objects in the wireless charging area, or wait for the wireless charging area to cool down before trying again. If charging is still unavailable, contact a BYD authorized dealer or service provider.
- After powering off, if the phone is still charging and the door is opened, there will be a sound alarm and a warning text will be displayed for 5 seconds.
- Phones must always be positioned horizontally in the charging area, whether for charging or not, otherwise gear shifting may be affected.

Luggage Compartment Cover*

- The luggage compartment cover is used for privacy and direct sunlight protection.
- Clip the two sides of the cover (1) into the lug boss of the lower trim of C pillar on both sides, and hang the strings on the trunk lid (2).
- Do the reverse to remove the cover.



! WARNING!

- When installing the luggage compartment cover, make sure that it is installed securely.
- Do not place any objects on the luggage compartment cover.
- Children are not to be allowed on the cover.

Infotainment System

Infotainment Control Panel PAD

When the vehicle is powered on, the initial screen will be displayed for several seconds and the system starts to work. It must be used after network connection to better experience Infotainment functions (such as APP and Internet calls).

- ① Infotainment touchscreen
- ② Scroll button

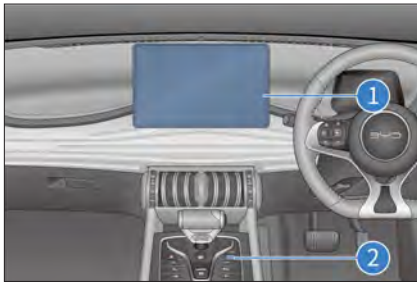

- Audio can be turned off when pressed and on when pressed again. The Infotainment System can be restarted when the button is pressed and held for over 3 seconds.
- Scroll up to turn volume up down to turn volume down. Volume ranges from 0 to 39. A "Mute" icon is displayed when volume is 0.

WARNING!

- Do not use a high-power inverter in the vehicle, as this may cause the infotainment system to malfunction.
- Do not format or root the device without authorization, or it will cause the infotainment system or the vehicle to malfunction.
- For driving safety, the use of landscape view is recommended while driving.

CAUTION!

- To prevent damage to the touch screen:
 - » Touch it gently. If there is no response, remove finger from the screen then touch it again.
 - » Clean the screen with a soft damp cloth. Do not use any cleaning product.
- Using the touch screen:
 - » When the display screen temperature is low, the displayed image may be darker, or the system may work slightly slower than normal.
 - » When wearing sunglasses, the screen may be dark or difficult to see. Change the viewing angle, or take off the sunglasses.
 - » The touch screen buttons that are grayed out cannot be operated.
- The touch screen interface shown here is for reference only.

Widgets

- When the Infotainment is ON, the widget screen is automatically displayed, which contains the following modules: top status bar, Vehicle settings, A/C, Navigation bar, and widget window:



Three small windows can be set in the widget interface, which can be customized:

1. Adding a widget: press and hold the widget icon to make it editable. Another widget icon is displayed at the bottom of the interface. Drag the widget icon to the desired position and release it.
2. Deleting a widget: press and hold the widget icon you want to delete, drag it to the delete icon on top of the interface, and then release it.
3. Changing position: press and hold a widget icon, drag it to the position of another widget, and then release it.

Quick access: pull down the top status bar to open a quick interface, including WLAN, mobile data, Bluetooth, mute, hot spot, screenshot, Auto rotate, remote location, brightness, other vehicle control switches and other shortcuts.

Language Setting

- When the vehicle is powered on, tap on  → **Dilink** → **More** → **Language** on the center console touch screen and set the language as Simplified Chinese or English.

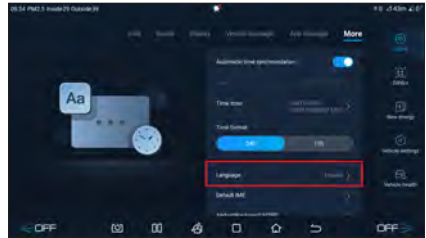

07 MAINTENANCE

Maintenance Information	154
Regular Maintenance.....	159
Self-Maintenance.....	163

Maintenance Information

Maintenance Cycle and Contents

Vehicle Maintenance Plan

- The maintenance plan is designed to ensure stable driving, failure reduction, safe and economical driving.
- Drivers can refer to the maintenance plan for scheduled maintenance intervals, depending on the odometer reading or time interval, whichever comes first.
- For overdue maintenance items, the same time interval should be used for maintenance.
- Rubber hoses (for A/C and heating systems, braking systems, etc.) should be checked by professional technicians according to the maintenance schedule.
- These are particularly important maintenance items whose maintenance intervals are recorded in the maintenance schedule. Hoses with any degradation or damage should be replaced immediately.
- The maintenance schedule lists all the maintenance items that are necessary to keep the vehicle in optimum condition at all times.
- It is recommended that the maintenance be performed in accordance with the standards and specifications of BYD Auto Co., Ltd., and by a local BYD authorized dealer or service provider.

- The maintenance schedule lists the maintenance items and travel time or distance based on the assumption that the vehicle is used as a normal means of transportation to carry passengers and goods that do not exceed the vehicle load limit.

CAUTION

- Please carry out regular maintenance of the vehicle according to the requirements in BYD Auto "Warranty and Maintenance Service Manual".

Maintenance Plan Requirements

The vehicle shall be maintained according to the regular maintenance schedule.

If the vehicle is operated primarily under one or more of the following special conditions, certain maintenance plan items may need to be performed more frequently.

- Road conditions
 - Driving on rough, muddy or slushy roads.
 - Driving on dusty roads.
- Driving conditions
 - Towed trailer, camping trailer or roof rack is used.

Maintenance Schedule

The vehicle maintenance is performed based on the mileage or months, whichever comes first.

Maintenance items	Maintenance interval
Chassis fastening anchor screws checkup	The initial inspection should be performed at 3 months or 5,000 km, the second inspection at 12 months or 20,000 km, and subsequent inspections every 12 months or 20,000 km, where damaged parts should be replaced in time.
Brake pedal and EPB switch checkup	The initial inspection should be performed at 3 months or 5,000 km, the second inspection at 24 months or 40,000 km, and subsequent inspections every 24 months or 40,000 km; where under harsh conditions, the initial inspection should be performed at 3 months or 5,000 km, the second inspection at 12 months or 20,000 km, and subsequent inspections every 12 months or 20,000 km.
Brake friction block and disk checkup	The initial inspection should be performed at 3 months or 5,000 km, the second inspection at 12 months or 20,000 km, and subsequent inspections every 12 months or 20,000 km.
Brake piping and hoses checkup	The initial inspection should be performed at 3 months or 5,000 km, the second inspection at 24 months or 40,000 km, and subsequent inspections every 24 months or 40,000 km; where under harsh conditions, the initial inspection should be performed at 3 months or 5,000 km, the second inspection at 12 months or 20,000 km, and subsequent inspections every 12 months or 20,000 km.
Guide pin of brake caliper assembly checkup	The initial inspection should be performed 12 months or 20,000 km, and subsequent inspections every 24 months or 40,000 km.
Steering wheel and lever checkup	The initial inspection should be performed at 3 months or 5,000 km, the second inspection at 24 months or 40,000 km, and subsequent inspections every 24 months or 40,000 km; where under harsh conditions, the initial inspection should be performed at 3 months or 5,000 km, the second inspection at 12 months or 20,000 km, and subsequent inspections every 12 months or 20,000 km.
Drive shaft boot checkup	The initial inspection should be performed at 3 months or 5,000 km, the second inspection at 24 months or 40,000 km, and subsequent inspections every 24 months or 40,000 km; where under harsh conditions, the initial inspection should be performed at 3 months or 5,000 km, the second inspection at 12 months or 20,000 km, and subsequent inspections every 12 months or 20,000 km.

Ball pin and boot checkup	The initial inspection should be performed at 3 months or 5,000 km, the second inspection at 24 months or 40,000 km, and subsequent inspections every 24 months or 40,000 km; where under harsh conditions, the initial inspection should be performed at 3 months or 5,000 km, the second inspection at 12 months or 20,000 km, and subsequent inspections every 12 months or 20,000 km.
Front and rear suspension checkup	The initial inspection should be performed at 3 months or 5,000 km, the second inspection at 24 months or 40,000 km, and subsequent inspections every 24 months or 40,000 km; where under harsh conditions, the initial inspection should be performed at 3 months or 5,000 km, the second inspection at 12 months or 20,000 km, and subsequent inspections every 12 months or 20,000 km.
Tires and inflation pressure (incl. TPMS) checkup	The initial inspection should be performed at 3 months or 5,000 km, the second inspection at 12 months or 20,000 km, and subsequent inspections every 12 months or 20,000 km, where damaged parts should be replaced in time.
Front and rear alignment checkup	The initial inspection should be performed at 3 months or 5,000 km, the second inspection at 24 months or 40,000 km, and subsequent inspections every 24 months or 40,000 km; where under harsh conditions, the initial inspection should be performed at 3 months or 5,000 km, the second inspection at 12 months or 20,000 km, and subsequent inspections every 12 months or 20,000 km.
Tire rotation	Check air pressure and tire condition at least once a month and rotate every 10,000 km.
Door stop checkup	Remove the dust from the lever with a damp soft cloth, and apply 0.3 to 0.8 g of grease to the lever, riveting joint and rotating shaft. The initial inspection should be performed at 3 months or 5,000 km, the second inspection at 12 months or 20,000 km, and subsequent inspections every 12 months or 20,000 km, where damaged parts should be replaced in time.
Wheel bearings clearance checkup	The initial inspection should be performed at 3 months or 5,000 km, the second inspection at 24 months or 40,000 km, and subsequent inspections every 24 months or 40,000 km; where under harsh conditions, the initial inspection should be performed at 3 months or 5,000 km, the second inspection at 12 months or 20,000 km, and subsequent inspections every 12 months or 20,000 km.
Auxiliary tank refrigerant level checkup	The initial inspection should be performed at 3 months or 5,000 km, the second inspection at 12 months or 20,000 km, and subsequent inspections every 12 months or 20,000 km, where damaged parts should be replaced in time.

Drive motor anti-freeze replacement	Replace the long acting organic acid refrigerant once every 4 years or 100,000 km, whichever comes first.
Brake fluid checkup	The initial inspection should be performed at 3 months or 5,000 km, the second inspection at 12 months or 20,000 km, and subsequent inspections every 12 months or 20,000 km, where damaged parts should be replaced in time.
Brake fluid replacement	Replace once every 2 years or 40,000 km.
Checking of vehicle module fault codes (cleared after recording)	The initial inspection should be performed at 3 months or 5,000 km, the second inspection at 12 months or 20,000 km, and subsequent inspections every 12 months or 20,000 km, where damaged parts should be replaced in time.
Power battery tray, guard plate, crash bar, and mount point torque (QH) checkup	The initial inspection should be performed at 3 months or 5,000 km, the second inspection at 12 months or 20,000 km, and subsequent inspections every 12 months or 20,000 km, where damaged parts should be replaced in time.
Capacity testing and calibration	Every 72,000 km or 6 months
Checkup and replacement of gear oil in transmission (NT30 transmission)	The initial replacement should be performed at 24 months or 40,000 km, and subsequent replacements every 24 months or 48,000 km.
Powertrain leaks or bumps checkup	The initial inspection should be performed at 3 months or 5,000 km, the second inspection at 12 months or 20,000 km, and subsequent inspections every 12 months or 20,000 km, where damaged parts should be replaced in time.
Loose HV harness or connectors checkup	The initial inspection should be performed at 3 months or 5,000 km, the second inspection at 12 months or 20,000 km, and subsequent inspections every 12 months or 20,000 km, where damaged parts should be replaced in time.
HV module appearance, deformation or oil stain checkup	The initial inspection should be performed at 3 months or 5,000 km, the second inspection at 12 months or 20,000 km, and subsequent inspections every 12 months or 20,000 km, where damaged parts should be replaced in time.
Checking of the interface of each charging connector for foreign bodies or ablations	The initial inspection should be performed at 3 months or 5,000 km, the second inspection at 12 months or 20,000 km, and subsequent inspections at every 12 months or 20,000 km, where damaged parts should be replaced in time.

Checking of the activated carbon HEPA filter*	The initial inspection should be performed at 3 months or 5,000 km, the second inspection at 12 months or 20,000 km, and subsequent inspections every 1 year or 20,000 km, whichever comes first. Where under harsh condition, check every 6 months and replace when necessary.
Checking of headlights, turning lights and cabin lighting	The initial inspection should be performed at 3 months or 5,000 km, the second inspection at 12 months or 20,000 km, and subsequent inspections every 12 months or 20,000 km, where damaged parts should be replaced in time.
Checking of headlights dimming function	The initial inspection should be performed at 3 months or 5,000 km, the second inspection at 12 months or 20,000 km, and subsequent inspections every 12 months or 20,000 km, where damaged parts should be replaced in time.
Passing beam initial down tilt calibration	Calibrate every 10,000 km
Checking of the EPS bonding for foreign bodies or ablations	The initial inspection should be performed at 3 months or 5,000 km, the second inspection at 12 months or 20,000 km, and subsequent inspections every 12 months or 20,000 km, where damaged parts should be replaced in time.
Checking of the EPS connector for loose and the connector pin for ablation	The initial inspection should be performed at 3 months or 5,000 km, the second inspection at 12 months or 20,000 km, and subsequent inspections every 12 months or 20,000 km, where damaged parts should be replaced in time.
Checking of the appearance of EPS ECU for corrosion	The initial inspection should be performed at 3 months or 5,000 km, the second inspection at 12 months or 20,000 km, and subsequent inspections every 12 months or 20,000 km, where damaged parts should be replaced in time.
Checking of the connection between EPS ECU and motor for foreign bodies or corrosion*	The initial inspection should be performed at 3 months or 5,000 km, the second inspection at 12 months or 20,000 km, and subsequent inspections every 12 months or 20,000 km, where damaged parts should be replaced in time.
Checking of the vehicle module for software update (updated if any)	The initial inspection should be performed at 3 months or 5,000 km, the second inspection at 12 months or 20,000 km, and subsequent inspections every 12 months or 20,000 km, where damaged parts should be replaced in time.
Checking of high voltage parts for wading marks	The initial inspection should be performed at 3 months or 5,000 km, the second inspection at 12 months or 20,000 km, and subsequent inspections every 12 months or 20,000 km, where damaged parts should be replaced in time.

Checking of wiper arm lock nut torque	The initial inspection should be performed at 3 months or 5,000 km, the second inspection at 12 months or 20,000 km, and subsequent inspections every 12 months or 20,000 km, where damaged parts should be replaced in time.
---------------------------------------	---

Checking of hood lock and fasteners	Check once every 12 months.
-------------------------------------	-----------------------------

When checking item 1, please replace chassis parts in time if any abnormal damage is found.

REMINDER

To keep the power battery in optimal conditions, it should be fully charged and discharged regularly (once every 6 months or 72,000 km, whichever comes first) for self-calibration. A BYD authorized dealer or service provider may also be contacted to carry out capacity testing and calibration.

Harsh conditions of use are:

- Frequent driving in dusty areas or frequent exposure to salty air.
- Frequent and sudden braking.
- Driving in cold weather.
- Frequent and sudden braking.
- Frequent use of a towed trailer.
- Use as taxi.
- Driving in congested urban areas at temperatures above 32°C for more than 50% of total driving time.
- Driving at speeds over 120 km/h at temperatures above 30°C for more than 50% of total driving time.
- Frequent overloading.

Regular Maintenance

Regular Maintenance

- Maintenance shall be performed according to the maintenance schedule to ensure optimum vehicle performance and reduced faults.
- Drivers can refer to the maintenance schedule for scheduled maintenance intervals, either odometer or time interval, whichever comes first.
- For overdue maintenance items, the same time interval should be used for maintenance.
- It is recommended that maintenance be performed in accordance with the standards and specifications of BYD Auto Co., Ltd., and by a local BYD authorized dealer or service provider.
- The maintenance schedule lists the maintenance items and travel time or distance based on the assumption that the vehicle is used as a normal means of transportation to carry passengers and goods that do not exceed the vehicle load limit.

CAUTION

- Please carry out regular vehicle maintenance according to the requirements in the BYD Auto "Warranty and Maintenance Service Manual".

Vehicle Corrosion Prevention

The most common causes of vehicle corrosion are:

- The underbody of the vehicle is covered in salt, dust and moisture.
- The vehicle or some of its parts are exposed to high humidity and high temperature for a long time.
- The paint layer or underlayer is scratched by minor collision or by stones and gravel.

To prevent vehicle corrosion, the following criteria should be observed:

- Wash the vehicle frequently.
 - If driving on saline roads in winter or living in coastal areas, wash the landing area of the vehicle at least once a month, and clean the chassis and hood with a water cannon or steam to reduce corrosion. Wash the chassis thoroughly after winter.
- Check body paint and trims
 - If any chip or crack is found on the paint, it must be repaired immediately to prevent corrosion. If fragments or cracks peel off from the metal surface, please go to a BYD authorized dealer or service provider for repair.

- Check the interior compartment
 - Moisture and dust will accumulate under the carpet and cause corrosion. Check the undersides of carpets frequently to make sure these areas are dry.
 - Special care should be taken when transporting chemicals, detergents, fertilizers, salt, and other substances, and such substances should be kept in appropriate containers for transportation. If spillage or leakage is found, clean immediately and keep dry.
- Use of fenders
 - Fenders can protect vehicles in saline areas or on gravel roads. The bigger and closer to the ground the fender, the better.
- Park in a well-ventilated and dry area.

Paint Maintenance Tips

- Do not perform secondary painting if there is no obvious scratches on the finish, so as to prevent mismatch or color incompatibility.
- When the vehicle is not used for a long period, it should be parked in a garage or a well-ventilated place, and special body cover should be used in winter. Choose a shady place for parking temporarily.
- Prevent strong impacts, knocks or scratches on the paint. If the paint is scratched, dented or if it peels, it should be repaired in time, which should be carried out by professional auto beauty provider.
- Do not touch the paint with a greasy cloth. Do not place greasy tools or rub with organic solvents on the vehicle body so as to avoid chemical reactions.

- The vehicle should be taken for a paint check regularly (once a month or whenever any problem is found), and waxed once every three months.
- High quality polish and wax must be used. If body finish is severely weathered, use a car cleaning polish separate from the wax. Carefully follow the manufacturer's instructions and precautions. Chrome finish should be polished and waxed as well as painted finish.

CAUTION

- The plastic bumper must be removed if the vehicle is to be repainted and parked in a high temperature painting and waxing workshop, as high temperatures will damage the bumper.

Vehicle Cleaning

- The vehicle must be cleaned in time under the following circumstances which will cause peeling of paint layer or corrosion of body and parts:
 - Driving along the coast.
 - Driving on a road on which anti-freeze has been applied.
 - Driving on roads covered with coal tar.
 - Resin, bird droppings and insect carcasses get stuck.
 - Driving in areas with a large amount of smoke, soot, dust, iron filings or chemicals.
 - Vehicles visibly soiled by dust or mud.
 - After raining.

Manual Car Washing

Before washing the vehicle, park it in the shade, and wait for the vehicle to cool down sufficiently.

1. Flush loose dirt with a hose to remove all mud or road salt from the bottom of the vehicle and wheel pits.
2. Wash the vehicle with neutral agents, the mixing of which should be carried out according to the manufacturer's instructions. Soak a soft cloth with cleaning solution and gently wipe it down along the direction of the water flow. Do not wipe in a circular motion or horizontally.
3. Rinse well - When the washing agent dries, it forms markings. After washing the vehicle in hot weather, rinse the parts properly.
4. Dry the vehicle with a clean soft towel to prevent stay water marks. In order to prevent scratching, do not rub or apply excessive force on the paint.

REMINDER

- Do not use alkaline washing powder, soapy water, dishwashing liquid, dewaxing detergent, or volatile solvents.
- When cleaning the light assemblies, do not wipe the surface of the combination lights with chemical solvents, such as gasoline, alcohol, lacquer thinner, paint thinner or carbon tetrachloride; otherwise, cracks will appear on the assembly guards.
- Vehicles driven in coastal areas or in heavily polluted areas should be rinsed every day.

REMINDER

- Do not scrape or use gasoline to remove dirt. The plastic wheel trims are easily damaged by organic matter. If any organic matter is splashed on the trims, it must be washed off with water and the trims must be checked for damage. If necessary, promptly replace plastic wheel trims that have been seriously damaged. Otherwise, they may fly off while the vehicle is in motion.
- Do not wash the bumper with cleaning agents that contain abrasives.
- The plated metal parts must be cleaned with a carbon cleaning agent, and waxed regularly for protection.

Automatic Car Washing

When choosing an automated car wash service, be aware of certain types of brushes, unfiltered rinsing water, or machine-specific rinsing procedures that may scratch the paint and affect its gloss and durability, especially darker colors. Before washing the vehicle, it is best to consult the staff of the car wash service provider to understand which washing procedures are the safest for the paint finish.

Interior Cleaning

REMINDER

- Prevent direct water splashes onto the dashboard or floor when washing the vehicle, as these may cause electrical faults.
- Do not wash the vehicle's floor.

Carpet Cleaning

- Clean carpets with a good foam detergent.
- Use a vacuum cleaner to remove as much dust as possible. There are several types of foam detergents available. Some are in spray cans, and the others are powders or liquids that are mixed with water. Clean the carpets with foam soaked sponge or a brush, scrubbing in a circular motion.
- Do not use plain water, and keep the carpets as dry as possible.

Seat Belt Cleaning

- The seat belts can be cleaned with neutral soapy water or lukewarm water.
- Scrub the seat belts with a sponge or soft cloth. Check the seat belts for excessive wear, tears or cut marks.

CAUTION

- Do not clean the seat belts with stain remover or bleach, so as not to weaken them.
- Do not use the seat belts until they are dry.

Cleaning Doors and Windows

- Doors and windows can be cleaned with any ordinary detergent.
- Check the door stops regularly. If the stop lever is found with visible dust accumulation, wipe it with a wet soft cloth.

CAUTION

- When cleaning the inside of the rear window, be careful not to scratch or damage the heating wire and the connector.

Cleaning of A/C Control Panel, Car Speakers, Dashboard Panel, Control Panel and Switches

- Clean the A/C control panel, car speakers, dashboard panel, control panel and switches with a wet soft cloth.

CAUTION

- Do not use organic substances (solvents, kerosene, alcohol, gasoline, etc.) or acid and alkali solutions. These chemicals can cause discoloration, staining or flaking. If any detergent or polishing product is used, make sure they do not contain any of these ingredients.
- If a new liquid washing agent is used, it must not come into contact with the vehicle's interior surfaces, as it may contain any of the previously mentioned ingredients. If there is any spillage, immediately clean it thoroughly.

Cleaning of Leather

- Leather trimmings can be cleaned with a neutral detergent used to wash woolen.
- Use a soft cloth with a neutral detergent solution to wipe off the dust, and then use a clean, wet cloth to wipe the remaining detergent thoroughly.
- If leather gets wet, wipe it with a clean soft cloth and let it dry in a cool, ventilated place.

- For any questions about vehicle cleaning, please consult a local BYD authorized dealer or service provider.

CAUTION

- If dirt cannot be cleaned off using a neutral detergent, clean it with a detergent that does not contain organic solvents.
- Do not clean leather with any organic material such as volatile oil, alcohol, gasoline, acid or alkali, as these will cause discoloration.
- Do not clean leather with a nylon brush or synthetic fiber cloth, as these may scratch the fine patterns on the leather surface.
- Mold may grow on dirty leather trimmings. Special care must be taken to avoid oil stains, and trimmings must always be kept clean.
- Prolonged exposure to sunlight will cause leather to harden or shrink, so the vehicle should be parked in a shady and cool place, especially in the summer.
- In hot weather, avoid placing vinyl or waxy items on the trimmings, as these may stick to leather in high temperatures.
- Improper cleaning of leather trimmings may cause discoloration or spots.

Self-Maintenance

Self-Maintenance

Self-Maintenance Precautions

- If maintenance is to be carried out by the owner, be sure to follow the correct steps in this section.

- Note that improper and incomplete maintenance will affect the good use of the vehicle.
- This section only lists instructions on simple maintenance items that can be done by the owner. However, there are many items that must be done by qualified technicians with special tools.
- Special care must be taken in maintaining vehicles to prevent accidental injuries.

CAUTION

- Some vehicle circuits and parts carry high current or high voltage. Beware.
- If refrigerant spills out, wipe it clean with a dry cloth or paper to prevent damage to parts or painted surfaces.
- If brake fluid spills out, rinse it with water to prevent damage to parts or painted surfaces.
- When replacing wiper blades, prevent them from scratching the glass surface.
- Before closing the hood, make sure there are no tools, cloths, etc., left inside.
- Goggles are to be worn whenever work is done under the vehicle, to prevent objects or liquids from falling into eyes.
- As brake fluid can damage the skin or eyes, caution should be exercised while filling the brake fluid. If brake fluid splashes on skin or eyes, wash immediately with plenty water. If discomfort persists, seek medical attention.

Tire Checks

The following items should be checked according to usage or specified mileage:

- Refrigerant level - Radiator refrigerant level should be checked at each charge.
- Windshield washer fluid - The residual amount of washer liquid in the tank should be checked monthly. When washer liquid is frequently used, the residual amount of liquid should be checked at each charge.
- Windshield wiper - Check the wiper condition monthly. If the wiper does not work, check it for wear, cracking or other damage.
- Brake fluid level - Check the level monthly.
- Brake pedal - Check that the brake pedal is operating properly.
- EPB switch - Check that the switch is functional.
- Engine compartment storage battery - Check the condition of the storage battery and terminals for corrosion monthly.
- A/C system - Check the operation of A/C units weekly.
- Tires - Check tire pressure monthly. Check tread wear and whether there are foreign bodies embedded.
- Windshield defroster - Check the vent of the defroster vent monthly.
- Headlights - Check the condition of headlights, lamps, rear lights, high brake lamps, turning lights, rear fog lights, brake lamps and license plate lamps monthly.
- Doors - Check that the trunk lid and all other doors (including rear doors) can be opened freely and locked securely.
- Horn - Check that the horn is working properly.

REMINDER

- There is risk of damage or accidents if the vehicle is driven for long periods without inspection.

Combination Lights

Calibration of front combination lights

- For each new vehicle, front combination lights are already calibrated in the factory. If the vehicle often carries heavy loads, the front combination lights may need to be re-calibrated. Go to a BYD authorized dealer or service provider for calibration.

Fogging of lights

- After heavy rain or cleaning, there may be fog on the combination lights, rear lights, and turning lights on the side mirrors. This is similar to condensation on the side window during rain and it is not a problem.
- The lights are located in a relatively closed and narrow space, and the temperature is very high when they light up (the mask and reflector are easy to be burned and deformed), so they need heat dissipation. There are heat dissipation holes on the lamp housing for convection. The greater the temperature difference, the more active the convection. Convection and other factors like sun exposure and bulb heat, can cause humidity to enter the lamp, so condensation may form on its surface.

REMINDER

- If moisture appears on the inside of the combination lights or on the inside of the turning lights on the side mirrors, this could be due to high humidity and/or large temperature difference. When driving, turn on the combination lights or turning lights, and condensation will dry out after a while.
- If there is a noticeable amount of water inside the lights, drive to a BYD authorized dealer or service provider for maintenance.

Sunroof Maintenance

Panoramic Sunroof Maintenance*

1. Wipe off dust or sand on the outer sealing strips of the sunroof with a damp cloth to avoid scratching them, which may affect their sealing performance.
2. Wipe off dust or sand on the molding edges of the front glass with a damp cloth to avoid scratching them, which may affect their sealing performance.
3. Fully open the front glass and frequently clean the front end of the rear glass to avoid the accumulation of dust, sand, and leaves, and prevent the drainage holes from being blocked by such debris, resulting in poor drainage of the sunroof.
4. Frequently clean the rails on both sides and the front sash to avoid the accumulation of dust, sand, and leaves, and prevent the drainage holes from being blocked by such debris, resulting in poor drainage of the sunroof.

5. When washing the vehicle, do not aim jets directly at the sealing strips with a water cannon, to prevent damage to the strips and water from leaking into the vehicle.
 6. The sunroof freezes easily in winter, the sealing strips or other parts may be damaged if the sunroof is forcibly opened. When the sunroof freezes, heat the vehicle and turn on the A/C system to accelerate the melting of snow and ice on the sunroof. Try to open the sunroof after the temperature inside reaches a certain level. Dry the residual moisture on the sunroof to prevent it from freezing.
 7. Do not open the sunroof fully on extremely bumpy roads. Otherwise, the vibration between the sunroof and the rail may cause deformation of related parts and even damage to the motor. Also, do not open the sunroof when it rains or the vehicle is being cleaned.
5. The sunroof freezes easily in winter, the sealing strips or other parts may be damaged if the sunroof is forcibly opened. When the sunroof freezes, heat the vehicle and turn on the A/C system to accelerate the melting of snow and ice on the sunroof. Try to open the sunroof after the temperature inside reaches a certain level. Dry the residual moisture on the sunroof to prevent it from freezing.
 6. Do not open the sunroof fully on extremely bumpy roads. Otherwise, the vibration between the sunroof and the rail may cause deformation of related parts and even damage to the motor. Also, do not open the sunroof when it rains or the vehicle is being cleaned.

Ordinary Sunroof Maintenance*

1. Wipe off dust or sand on the sealing strips of the sunroof with a wet cloth to avoid scratching them, which may affect their sealing performance.
2. Wipe off dust or sand around the roof metal sheet with a wet cloth to prevent abrasion of sealing strips when the sunroof is closed, which may affect the sunroof sealing performance.
3. Frequently clean the rails, front sash and other parts to avoid the accumulation of dust, sand, and leaves, and prevent the drainage holes from being blocked by such debris, resulting in water leakage into the vehicle.
4. When washing the vehicle, do not aim jets directly at the sealing strips with a water cannon, to prevent damage to the strips and water from leaking into the vehicle.

Vehicle Storage

- If the vehicle needs to be parked for a long time (more than a month), the following preparations should be made. Proper preparation helps prevent degradation and ensure easy reuse of the vehicle. If possible, park the vehicle indoors.
- Charge the vehicle on time. For details, see **Battery Usage Tips**.
- Thoroughly clean and dry the body surface.
- Clean the interior of the vehicle to ensure that carpets and mats are completely dry.
- Release the parking brake and set the gearshift lever in parking gear.
- Open one window slightly (if stored indoors).
- Disconnect the 12 V battery negative terminal in engine compartment.
- Pad the front wiper arm with a folded towel or cloth to keep it out of contact with the windscreen.

- To reduce adhesion, apply silicone lubricant to all door seals and body wax to the painted surface where the door seals meet.
- Cover the body with a breathable covering made of a "porous material" such as cotton. Non-porous materials, such as plastic sheeting, can build up moisture and damage the paint.
- If possible, start the vehicle regularly (preferably monthly). If the vehicle has been parked for a year or more, go to a BYD authorized dealer or service provider for comprehensive maintenance.

Hood

Opening the Hood

1. Pull the handle twice and the hood will unlock and open slightly.

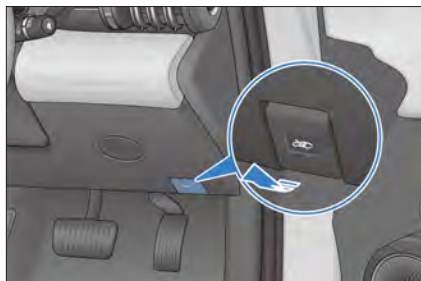

2. Open the hood: Lift the hood and support it with the rods.
3. Close the hood: When closing the hood, lower it to about 30 cm above the front grille and release it, so the fall locks it.
4. After closing the hood, check that the latch is securely locked.



⚠ REMINDER

- Confirm that the hood is closed and locked securely. Otherwise, while driving, the hood may suddenly open and cause an accident.

Cooling System

- It is required that the liquid level should be between the MAX and MIN marker lines of the auxiliary refrigerant radiator.
- The refrigerant should always be of the same specification as the original refrigerant, without adding any mixture. Different brands and types of refrigerant should not be mixed.

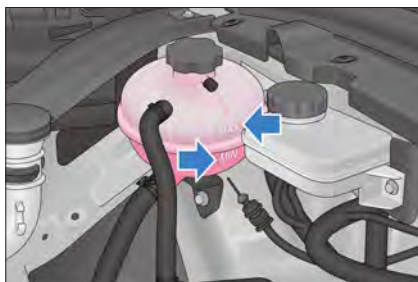

- If the level is below the MIN line, refrigerant should be refilled to the MAX line. Check the cooling system for leakage.

! REMINDER

- Opening the refrigerant tank cap when the engine is not yet completely cooled may cause refrigerant to squirt out, resulting in severe burns.
- Battery refrigerant may fade in color when exposed to high ultraviolet rays such as sunlight. If the hood needs to be opened in the process of car use and maintenance, direct sunlight should be avoided. The performance parameters of refrigerant do not change after it fades, and normal use is not affected.

! CAUTION

- Do not add any rust inhibitor or other additive into the cooling system, for it may be incompatible with the refrigerant or the motor assembly.
- Before opening the reservoir cap, make sure that the motor, high-voltage electronic control assembly, refrigerant reservoir and radiator are all cooled down.
- It is recommended to go to a BYD authorized dealer or service provider to add refrigerant that is compatible with the battery.

Braking System

- The liquid level in the tank should be checked monthly, and the brake fluid should be replaced according to the travel time and mileage specified in the regular maintenance schedule.
- Be sure to use the brake fluid of the same specifications as the original brake fluid, and different types of brake fluid should not be mixed.

- It is required that the liquid level should be between the MAX and MIN marker lines of the tank.
- If the gauge shows a low brake fluid level, check the brake system for leakage and brake lining for abrasion.

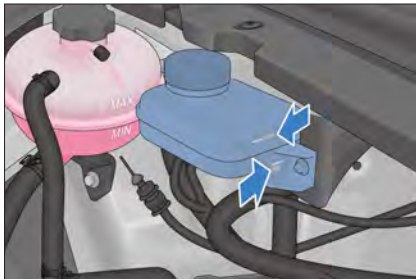

Windshield Washer

- During normal use, check the liquid level of the windshield washer reservoir at least monthly.
- If the windshield washer is used frequently, the level of the washer reservoir should be checked more frequently.
- High quality windshield washer fluid should be added to improve stain removal and prevent freezing in cold weather.



- When refilling the washer fluid, use a clean cloth dipped in the windshield washer fluid to clean the windshield wiper blade, thus helping keep the wiper blade in good condition.

CAUTION

- Do not inject vinegar-water solution into the windshield washer fluid reservoir.
- It is recommended to use certified windshield washing fluid.

Air Conditioning System

- The A/C system is a closed system, and any important maintenance work should be performed by professionals from a BYD authorized dealer or service provider.
- Owners can perform the following operations to ensure that the A/C system works effectively.
 - Check the radiator and A/C condenser regularly.
 - Remove leaves, insects, and dust from the front surface, which can block airflow and reduce cooling.
 - In cold months, the A/C should be turned on at least once a week for at least 10 min each time, to allow the circulation of lubricating oil contained in the refrigerant.
- If A/C efficiency decreases, go to a BYD authorized dealer or service provider for maintenance.

CAUTION

- Whenever the A/C system is inspected and repaired, the maintenance station should be required to ensure the use of refrigerant recirculation equipment. This equipment can recover refrigerant for reuse. Improper disposal of refrigerant pollutes the environment.

Wiper Blades

The blade strip is made of synthetic rubber, which is a vulnerable part. The working environment of vehicles and the usage habits of drivers may cause damage to the blade. Therefore, please note the following items to ensure the service life of the blade and the driving safety of the vehicle:

- Do not use a blade to remove ice from the windshield surface. Use a dedicated ice scraper.
- Do not scrape the windshield surface if it is dirty, greasy or waxy.
- Keep the windshield surface clean. Do not scrape dust, sand, insects, and foreign bodies on the windshield surface.
- During vehicle washing and body paint maintenance, there is no need to wax the windshield, as the wax layer reflects light in bad light, affecting the line of sight and driving safety. After washing the vehicle, rinse the blade with plain water, and use special windshield wax cleaner to remove the wax layer on the windshield.
- Do not wash the blades directly with a water gun to prevent excessive water pressure from damaging the blades.

Maintenance Rules

- Clean windscreen and blade regularly (preferably once a week or once every two weeks).
- Wipe the wiper regularly (preferably once a day or once every two days). When using a blade to wipe the windshield, keep the windshield fully wet (when there is no rain, the washer liquid must be sprayed in advance).
- Clean the windshield with a special windshield washer fluid.
- Promptly clean mud and insect carcasses stuck to the windshield with a rag.

- When there are marks on the windshield caused by gravel, maintenance should be carried out timely (it is recommended that windshield repair resin products should be used and the windshield should be replaced if marks are too large or too many).
- Replace the wiper blades regularly, preferably once every six months.
- When cleaning the windshield, the wiper arm must be raised in advance. The specific operation method is as follows:
 1. Go to Infotainment → Vehicle health → Maintenance to enable front wiper maintenance, and the wiper will be rotated down.
 2. Grasp the upper end of the wiper arm and carefully lift the wiper arm and blade assembly.
- Over-inflated tires wear unevenly, reduce comfort, and are prone to damage from uneven roads. If seriously over inflated, there is a risk of bursting, seriously threatening safety.
- The vehicle is equipped with a tire pressure gauge. When the tire is at ambient temperature, owners can decide whether to replenish tire pressure according to the tire pressure value displayed on the gauge.
- Tire pressure should be measured while the tire is cold. This means that it should be measured at least three hours after parking. If the owner must drive the vehicle before the tire pressure is measured, the tire can still be considered cold as long as the travel distance is not more than 1.6 km.
- If the tire pressure is checked while the tire is hot, the reading will be 30 - 40 kPa (0.3 - 0.4 bar) higher than the cold reading. This phenomenon is normal. Do not deflate in order to achieve the specified cold tire pressure reading; otherwise pressure will be insufficient.

Tires

- For safe driving, tires must be made and sized to fit the vehicle, with good tread and standard tire pressure.

WARNING

- Using excessively worn tires, or with too high or low pressure, poses a high risk of accidents.
- Follow all of the instructions in this manual on tire inflation and maintenance.

Tire Inflation

- Keep tires properly inflated to provide the best combination of handling, tread life and driving comfort.
- Under-inflated tires can cause uneven tire wear, affect handling and energy consumption, and they are more prone to leakage due to overheating.

REMINDER

- The recommended tire pressure label (stuck on the driver's side door frame) indicates the recommended cold tire pressure.
- Tubeless tires have a self-sealing function when they are punctured. However, as the leak is usually very slow, as soon as the tire begins to depressurize, carefully look for the leak location.

Tire Checks

- When checking the tire inflation each time, check tires for damage, foreign body piercing and wear.



- Replace the tire if bumps, or tread or side damage are found.
- Replace the tire if there are cracks on its side, or if its fabric or cord can be seen.
- Replace tires with excessive tread wear.
- Tire treads are cast with wear marks. When the tread is worn at this point, tread thickness is less than 1.6 mm. The adhesion of tires worn to this extent is very small on wet roads.
- When the tread is worn to the point where the wear mark is exposed, there is serious performance loss, and the tires should be replaced.

Maintenance

- In addition to proper inflation, proper wheel alignment also helps reduce tread wear.
- If uneven tire wear is found, go to a BYD authorized dealer or service provider and check the wheel alignment.
- The vehicle has been balanced in the factory, but tires need to be re-balanced after driving for a period of time.
- If there is some kind of continuous vibration while driving at high speeds (above 80 km/h), but not at low speeds, go to a BYD authorized dealer or service provider and check the tires.

- If a tire has been repaired, be sure to re-balance it.
- When installing a new tire or replacing a new wheel, always perform tire balancing.

CAUTION

- Improper wheel balancers will get stuck, become loose and fall off. While driving, this will damage the car or surrounding objects.
- Improper wheel balancers will damage the aluminum rims of the vehicle. Therefore, it is recommended to use original wheel balancers.

Tire Rotation

- Tire rotation should be performed regularly, as well as four-wheel alignment, inspection and adjustment, so as to make tire wear the same and prolong the service life of tires.
- When buying replacement tires, some tires are 'directional,' which can only be shifted in one direction. If directional tires are used, only the front and rear wheels can be swapped in tire rotation, as shown:

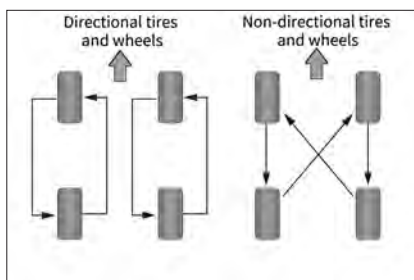

Replacing Tires and Wheels

- Original tires maximize performance, while providing the best combination of handling, driving comfort and service life.
- Go to a BYD authorized dealer or service provider for replacement of original tires.
- Replacement of tires with different sizes, road ranges, rated speeds and maximum cold pressures (marked on the tire side) or mixed use of radial tires and diagonal tires can reduce braking ability, driving force (ground adhesion) and steering accuracy.
- The installation of unsuitable tires can affect the maneuverability and stability of the vehicle, and may lead to accidents.
- It is best to replace all four tires at once. Do not replace only one tire; otherwise it will seriously affect the maneuverability of the vehicle.
- ABS works by comparing wheel speed. When replacing a tire, use a tire of the same size as the original tire. The size and structure of the tire can affect wheel speed and may lead to uncoordinated system operation.
- If the wheel needs to be replaced, ensure that the specifications of the new wheel match those of the original wheel. New wheels are available for purchase at a BYD authorized dealer or service provider. Please consult a BYD authorized dealer or service provider before replacing the wheels.

REMINDER

Observe the following instructions, otherwise it will lead to typical handling hazards, which will cause the vehicle to lose control.

- Do not mix radial tires, bias belted tires or diagonal ply tires.
- Only use the tire sizes recommended by the manufacturer.

Fuses

All vehicle circuits are provided with fuses to prevent short circuits or overloading. These fuses are mounted in the motor compartment in front cabin switchboard and dashboard panel switchboard, respectively. Fuse diagrams showing the correspondence between the fuses and their respective parts are stuck to the fuse boxes.

- The fuse under the hood is located on the rear left side of the motor compartment. To open it, remove the trim first, and press the latch:

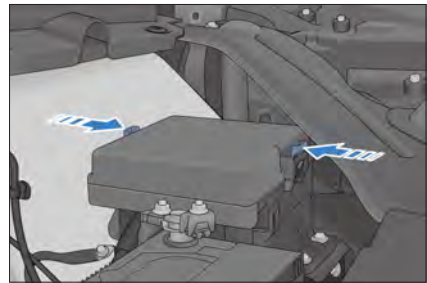

- The dashboard panel fuse under the driver side is located on the right side of the dashboard. Remove the body fuse under the dashboard panel to repair.



- Replacement of blown fuses with ones of higher amperage can increase the likelihood of damage to the electrical system.
- If there is no spare fuse in the same amperage, use a fuse with a lower amperage instead.

REMINDER

- Do not use a fuse with a higher rated ampere value, or any other solution to replace the fuse, as this may cause serious damage or even a fire.
- If a fuse blows, go to a BYD authorized dealer or service provider for inspection or replacement.

Under Hood PDB Nameplate

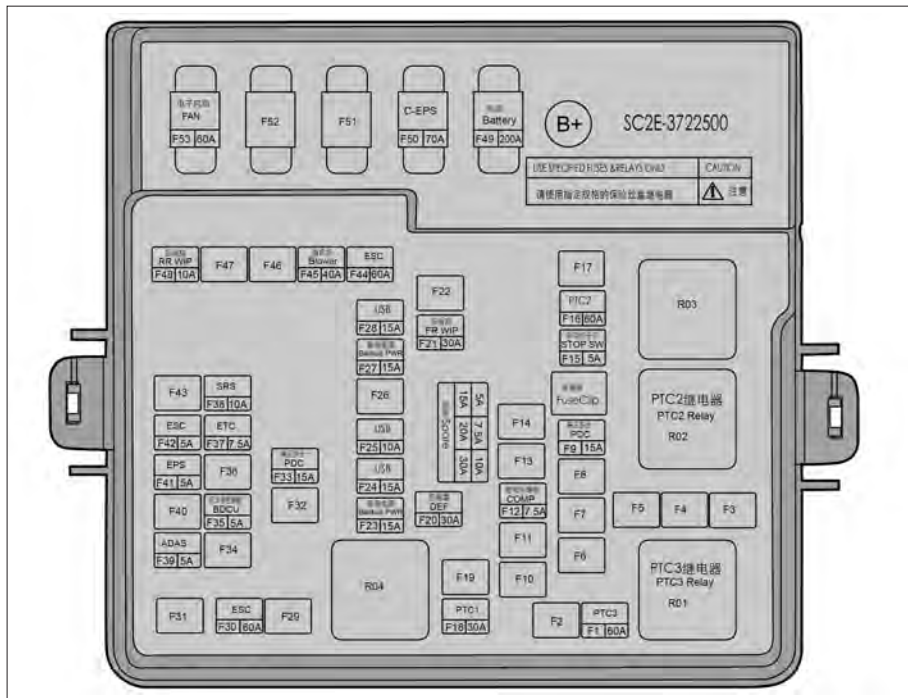

Number	Ampere (A)	Protected Component or Circuit
F1	60	PTC3
F2	-	-
F3	-	-
F4	-	-
F5	-	-
F6	-	-
F7	-	-
F8	-	-
F9	15	High-voltage all-in-one
F10	-	-
F11	-	-

F12	7.5	Electric compressor
F13	-	-
F14	-	-
F15	5	Brake light switch
F16	60	PTC2
F17	-	-
F18	30	PTC1
F19	-	-
F20	30	Rear windshield defroster
F21	30	Front wipers
F22	-	-
F23	15	Auxiliary power outlet
F24	15	USB
F25	10	USB
F26	-	-
F27	15	Auxiliary power outlet
F28	15	USB
F29	-	-
F30	60	ESC
F31	-	-
F32	-	-
F33	15	High-voltage all-in-one
F34	-	-
F35	5	Rear body controller
F36	-	-
F37	7.5	ETC
F38	10	SRS
F39	5	ADAS

F40	-	-
F41	5	EPS
F42	5	ESC
F43	-	-
F44	60	ESC
F45	40	Blower
F46	-	-
F47	-	-
F48	10	Rear wiper
F49	200	Batteries
F50	70	C-EPS
F51	-	-
F52	-	-
F53	60	Electric fan

Dashboard Panel PDB Nameplate

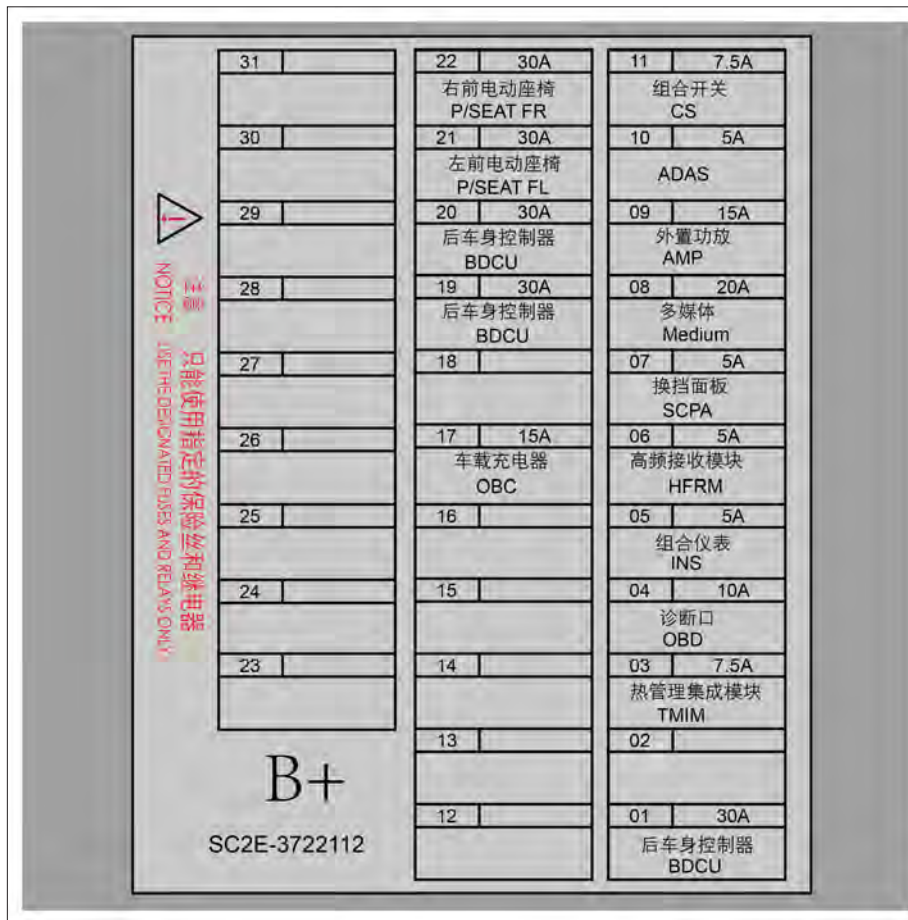

07

MAINTENANCE

Number	Ampere (A)	Protected Component or Circuit
01	30	Rear body controller
02	-	-
03	7.5	Thermal management integrated module
04	10	Diagnostic port
05	5	Instrument cluster
06	5	High-frequency receiving module

07	5	Shift panel
08	20	Infotainment system
09	15	External power amplifier
10	5	ADAS
11	7.5	Combination switch
12	-	-
13	-	-
14	-	-
15	-	-
16	-	-
17	15	On-board charger
18	-	-
19	30	Rear body controller
20	30	Rear body controller
21	30	Front left
22	30	Front right
23	-	-
24	-	-
25	-	-
26	-	-
27	-	-
28	-	-
29	-	-
30	-	-
31	-	-

 **REMINDER**

- Different vehicle configurations have some different fuse amperages (such as multimedia). Maintenance and replacement should be based on the actual object.

08

WHEN FAULTS OCCUR

When Faults Occur182

When Faults Occur

If Smart Key Battery is Exhausted

If the smart key indicator does not flash and the vehicle can't be started using the start function, the smart key battery may be exhausted. In this case, contact a BYD authorized dealer or service provider as soon as possible to change the battery. At this time, the vehicle can be started in no-power mode.

CAUTION!

- Do not expose the key to high temperatures.
- Protect the key from impact.
- Keep the key away from magnetic fields.
- When doors are locked and the vehicle is in anti-theft mode, keep the key away from the vehicle, as the vehicle's automatic card search function will drain the low-voltage battery power.

1. Use the mechanical key to unlock the vehicle.
2. Depress the brake pedal and meanwhile press the Start button. Then, the smart key warning light goes on and the speaker in the vehicle beeps once.
3. Keep the electronic smart key close to the no-power mode sign within 30 seconds after the speaker beeps. Then the smart key warning light goes out, and the vehicle can be started within 5 seconds.

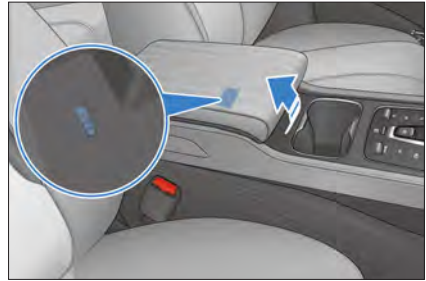

Emergency Shutdown System

- The emergency shutdown system is activated and the high-voltage system is automatically shut down when the following conditions are met:
 - The airbags do not deploy after a frontal collision.
 - There is a rear collision.
 - The vehicle system is faulty.
- If any of the above collisions and vehicle system failures occur, the OK indicator goes off.
- In these types of collision, activating the emergency shutdown system can minimize injuries or accidents.
- Once the emergency shutdown system is activated, the vehicle system cannot be switched into OK status. In this case, contact a BYD authorized dealer or service provider for help. Even if the ignition switch is set to the OK position, the system will be turned off immediately, and contact a BYD authorized dealer or service provider as soon as possible.

Vehicle Fire Rescue

In case of fire, continue to operate the vehicle as follows according to the actual situation:

1. Set the ignition switch to the OFF position, and leave the vehicle.
2. On the precondition that personal safety is ensured, if the fire is small and slow, use a dry powder fire extinguisher to put out the fire, and call for help immediately.
3. If the fire is large and growing quickly, stay away from the vehicle and call the fire brigade, informing them that the vehicle is equipped with a high-voltage battery pack, and wait for rescue.

CAUTION!

- Wear insulated gloves; Use the specified type of fire extinguisher. Using water or an incorrect fire extinguisher to extinguish the fire may result in electric shock.
- In the case of special circumstances resulting in flying projectiles (such as interior trimming parts, glass, etc.) stay away from the vehicle. Contact a BYD authorized dealer or service provider to go to the site to deal with it.

Battery Leakage Rescue

If there is battery leakage, if there is an acrid smell, or if there is visible acid flow or smoke after a collision:

1. Set the ignition switch to the OFF position, and disconnect the battery under the hood if conditions allow.

2. Call a BYD authorized dealer or service provider and the fire brigade, informing them that the vehicle is equipped with a high-voltage battery pack, and wait for rescue.

In Case of Collision

In case of collision, continue to operate the vehicle as follows according to the actual situation:

1. Set the ignition switch to the OFF position, and disconnect the battery under the hood if conditions allow.
2. Call a BYD authorized dealer or service provider, and wait for rescue.
3. Carry out a simple inspection, if conditions allow: check whether any edge of the power battery tray is cracked and whether any obvious liquid flows out.
 - Damage to high-voltage components is not identifiable in all cases. Do not handle damaged components or touch them with jewelry or other metal objects.
 - If there is skin contact with leaked fluid, wash it immediately with plenty of water for 10 - 15 minutes. If there is still any discomfort, apply 2.5% calcium gluconate ointment, or soak in 2% to 2.5% calcium gluconate solution. If discomfort persists, seek medical help immediately.
 - Do not touch the orange high-voltage cables or other high-voltage components. Only authorized repair personnel is allowed to work on high-voltage systems.
 - Do not damage, modify, disassemble, or disconnect the orange high-voltage cables from the high-voltage grid.

- Inform the firemen and rescue personnel that the vehicle is equipped with a high-voltage battery pack.

! WARNING!

- Do not touch the leaked fluid. Stay away from the vehicle.
- Do not dispose of the leaked fluid in water or soil.
- This vehicle uses high voltage DC power supply. The system can generate high heat before and after the vehicle is started or powered off. Beware of high temperatures.
- Do not disassemble, move, or change any high voltage battery part or connecting wire, as the connector can cause serious burns or electric shock. The orange cables are part of the high voltage harness. Users must not repair the high voltage system by themselves. If any repair is required, go to a BYD authorized dealer or service provider for repair.
- The remote control key and high voltage components may harm personnel carrying medical devices.

If the Vehicle Needs Towing

If the vehicle needs to be towed, contact a BYD authorized dealer or service provider, a professional towing service, or a roadside assistance service, if there is prior membership.

! WARNING!

- The vehicle must not be towed by other vehicles using only ropes or chains.

Common towing methods include:

- Flatbed trailer
 - When the vehicle is faulty and needs towing, a flatbed trailer is the best choice. There may be damage if the front wheels touch the ground.



Towing Hook

The installation position of vehicle towing hook is as shown.

1. Pry it open with a cross screwdriver.
2. Install the towing hook in the towing hole.

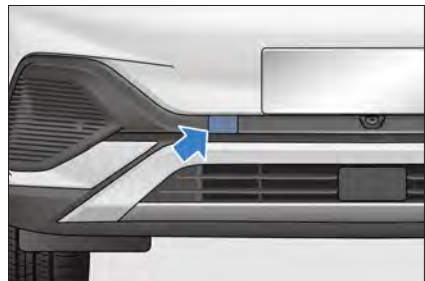

! REMINDER

- Towing the vehicle with the towing hook is not recommended.
- Only the vehicle's original towing hook is to be used.

In Case of a Flat Tire

- In case of a flat tire, slow down, keep straight and move off the road to a safe place.
- Park on solid, flat ground and avoid highway forks.
- Pull the EPB switch and press the "P" button.
- Power off the vehicle and turn on the emergency warning light.



- All passengers on-board must leave the vehicle to a safe location away from heavy traffic.
- Fasten the vehicle to prevent slipping, and wedge the tire in the diagonal to the flat tire.

! REMINDER

- Do not continue driving the car with a deflated tire. Driving even a short distance can cause too severe damage for the tire to be repaired.

In-Vehicle Tools

The in-vehicle tools are stored in the toolkit under the trunk cover.

In-vehicle tools include: Warning triangle, reflective vest, wheel nut cover removal clamp, tire repair device, towing hook, and other tools.



! REMINDER

- If the vehicle breaks down and an emergency stop is needed, promptly put on the reflective vest.

Placing warning triangle

! REMINDER

- When parking for repair, remember to place the red triangle side facing oncoming vehicles, 100-200 m away from the vehicle.

The warning triangle is important to alert oncoming vehicles and prevent accidents.

Warning triangle use

1. Remove it from its box.
2. Attach the ends to form a triangle.
3. Mount the supports as shown.



Automatic Tire Sealant*

- The tire sealant is used to seal small cuts, especially tread cuts or punctures. It is just an emergency solution for driving to the nearest service provider, and only for short emergency stretches, even if the tire is not deflated.

! WARNING!

- At most, the tire sealant can repair holes within 6 mm in diameter. If the diameter is larger than 6 mm or the hole is in another position on the tire, do not use this product. Call for roadside assistance.
- Tire sealant is highly flammable and harmful to health. Take the necessary precautions to prevent fire and avoid contact with skin, eyes and clothing; keep away from children; and do not inhale its vapor.

When coming into contact with tire sealant:

- If the tire sealant comes into contact with the skin or gets into the eyes, thoroughly rinse the affected body part immediately with plenty of clean water.
- Change contaminated clothing immediately.

! WARNING!

- In case of an allergic reaction, seek medical attention immediately.
 - If tire sealant is ingested, rinse mouth thoroughly and drink plenty of water immediately. Do not induce vomiting; seek medical attention immediately.
- For further information, refer to the manual supplied with the automatic inflating tire sealant, or scan the QR code on the manual to view the operation video.

! REMINDER

- Using tire sealant on damaged tires is only an emergency repair method. Please go to a professional maintenance center to replace the tire as soon as possible. Contact a BYD authorized dealer or service provider, and inform the maintenance technician that tire sealant has been used.
- Quick acceleration and turning at higher speeds must be avoided.
- Do not exceed the 80 km/h maximum speed limit. While driving, if the vehicle vibrates strongly, the driving performance is unstable or there is noise, stop driving.
- When the tire sealant is about to expire (see the label on the can for the exact date), replace it with a new one.
- After using the tire sealant, buy a new one at a BYD authorized dealer or service provider.

When the Battery Runs Out

When the vehicle cannot start due to low battery level, try to start it in the following steps:

1. Open the hood. (Please refer to "Maintenance - Self-Maintenance – Hood".)
2. Connect one end of the red positive (+) cable to the positive terminal (+) of the undercharged battery of the vehicle being rescued.

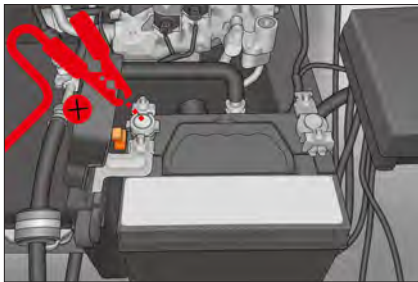

3. Connect the other end of the red positive (+) cable to the positive terminal (+) of the charged battery of the rescue vehicle.



4. Connect one end of the black negative (-) cable to the negative terminal (-) of the charged battery of the rescue vehicle.



5. Connect the other end of the black negative (-) cable to a suitable grounding point (a clean and unpainted firm grounded metal part) of the vehicle being rescued.
6. Start the rescue vehicle and keep it running for a while. Then try starting the vehicle being rescued.
7. After the vehicle being rescued starts normally, turn off the power of the rescue vehicle, remove the jumper cables in the order reverse to that connecting them and put them away.
8. Close the hood.

⚠ WARNING!

- If the jumper cables are connected or disconnected in the wrong order, short circuit may occur, resulting in vehicle damage or personal injury.
- When starting the vehicle with jumper cables, the clamps of the jumper cables must not contact each other or any conductive parts other than the jumper points, to avoid short circuits.

CAUTION!

- If the vehicle being rescued cannot be started after several attempts, contact a BYD authorized dealer or service provider.
- The rated battery voltage of the rescue vehicle should be 12V for starting with jumper cables.

WARNING!

- Do not place the lifting boom or the jack on the power battery.
- Ensure firmness when lifting or jacking up the vehicle.
- When jacking up the vehicle, do not have any part of your body under the vehicle.

When the Vehicle Needs Supporting

If the vehicle is needed to be lifted or jacked up, the lifting boom or the jack can only be placed at the lifting points as shown in the figure.

To ensure safety, pay attention to the following tips before lifting or jacking up a vehicle.

- Park the vehicle on the firm and flat ground.
- Switch the vehicle power supply to "OFF", and all occupants should leave the vehicle.
- When jacking up the vehicle, wedge the front wheels in the front or rear wheels behind them to prevent sliding.



09

VEHICLE SPECIFICATIONS

Data Information	188
Tips	192

Data Information

Vehicle Parameters

Dimensions:

Length (mm)	4455
Width (excluding side mirrors)	1875
Height (mm)	1615
Wheelbase (mm)	2720
Front track (mm)	1575
Rear track (mm)	1580
Front overhang (mm)	888
Rear overhang (mm)	847
Approach angle (°)	19
Departure angle (°)	24

Vehicle mass parameters:

Curb weight (kg)	1750	1680
Max. allowable total mass (kg)	2160	2090
Front axle load at max. allowable total mass (kg)	1070	1054
Rear axle load at max. allowable total mass (kg)	1110	1056
Number of passengers	5	

Drive motor parameters:

Drive motor model	TZ200XSQ
Drive motor type	Permanent magnet synchronous motor
Drive type	4x2 front-wheel drive
Rated power/revolving speed/torque of drive motor (kW/RPM/N•m)	65/4433/140
Peak power/revolving speed/torque of drive motor (kW/RPM/N•m)	150/4620/310

Power performance parameters:

Max. design speed (km/h)	160
Max. gradeability (%)	30

Vehicle economic parameters:

Power consumption per 100 km under comprehensive working conditions (kWh/100 km)	≤14.9	≤14.8
Driving range under comprehensive working conditions (km)	480	410

⚠ CAUTION!

- Actual power consumption depends on factors such as vehicle conditions, road conditions and driving habits.

Wheel and tire parameters:

Tire specifications	215/55R18	215/60R17; 215/55R18
Tire pressure (kPa)	250	
Wheel balance (g)	≤10	

Wheel alignment values (under curb weight):

Front wheel camber (°)	-0.9±0.75
Total front wheel toe-in (°)	0.116±0.16
Kingpin inclination angle (°)	11.47±0.75
Kingpin caster angle (°)	3.23±0.75
Rear wheel camber (°)	-1.07±0.5
Total rear wheel toe-in (°)	0.17±0.2

Braking system technical parameters:

Free stroke of brake pedal (mm)	≤ 5
Reasonable thickness range of front brake disc (mm)	24~26
Reasonable thickness range of rear brake disc (mm)	10~12
Reasonable thickness range of front brake lining (mm)	2~8
Reasonable thickness range of rear brake lining (mm)	2~6.5

Power battery parameters:

Power battery type	Lithium iron phosphate battery	
Rated capacity of power battery (AH)	150	135

Fluid parameters:

Maintenance Item	Type
Gear transmission oil type	Castrol BOT384 (recommended), Castrol ON D2
Gear transmission oil amount (mL)	600 ± 50
Motor refrigerant type	Glycol organic acid refrigerant -25/-40
Motor refrigerant amount (L)	3.9 ± 0.1 L
Brake fluid type	DOT4 or HZY6
Brake fluid amount (mL)	1050 ± 50

Seat parameters (when measuring seat depth):

Seat back angle set for front seats	23°
Front and rear seat positions set for front seats	200 mm forward and 60 mm backward from designed position; slide rail inclination: 4.5°
Normal service conditions of front seat backrests	Seat backs 22.5° forward and 52.5° backward from designed position
Seat back angle set for rear seats	27°
Front and rear seat positions set for rear seats	Design condition, not adjustable (lay down when unlocked)
Normal service conditions of rear seat backrests	27°

Vehicle Identification

Vehicle Identification Number (VIN)

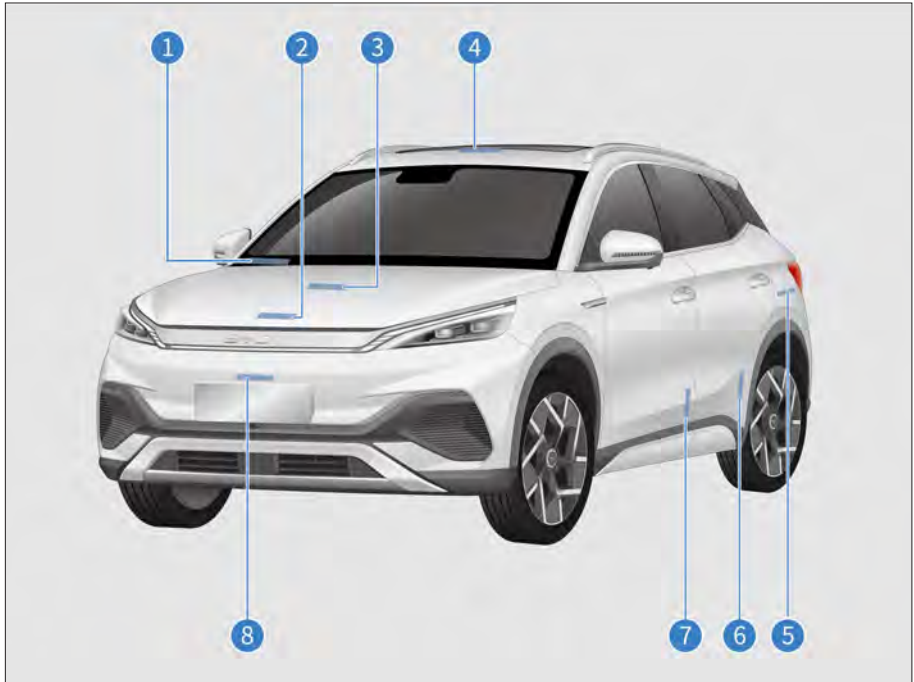

- | | | | |
|---|---|---|---|
| 1 | Attached to the VIN slot on the upper cover of the right front windshield cross sill; | 5 | Attached to the sheet metal clad of the right rear wheel; |
| 2 | Attached to the gearbox body; | 6 | Attached to the sheet metal surface inside the right rear door sill; |
| 3 | Attached to the sheet metal surface inside the hood; | 7 | Attached to the sheet metal surface at the lower right corner of the front left door; |
| 4 | Attached to the lower right side of the trunk sheet metal; | 8 | Attached to the sheet metal surface of the front anti-impact beam; |

VIN is engraved on the lower beam of the front right seat.

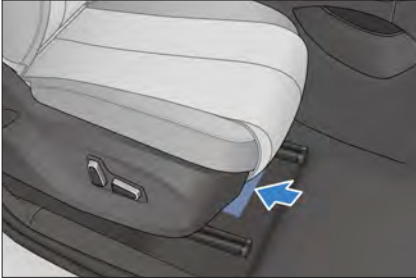

Note: The vehicle identification number (VIN) can be read in the upper right corner after selecting the model by connecting the VDS. For details, please refer to the VDS operation manual.

Vehicle Nameplate

It is attached to the metal sheet surface below the left B pillar and contains the following information:

Company name, brand, country of manufacture, vehicle model, seating capacity, year and month of manufacture, drive motor model, peak power of drive motor, rated voltage of high voltage battery system, rated capacity of power battery system, vehicle identification number, and maximum allowable total weight.



Drive Motor Model and Number

(1) The model and number of the drive motor are located near the lock ring right under the hood.

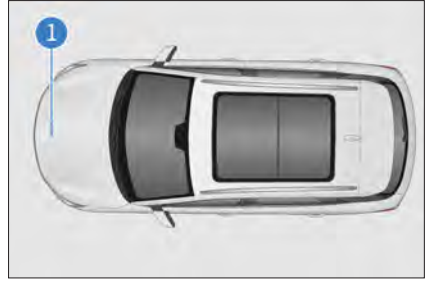

Tips

Warning Labels

- (1) A/C system and cooling fan sticker
- (2) Battery position sticker



Side airbag warning labels are attached below the left and right B-pillar lock rings.



Airbag warning labels are printed on the front and back of the left sun visor.

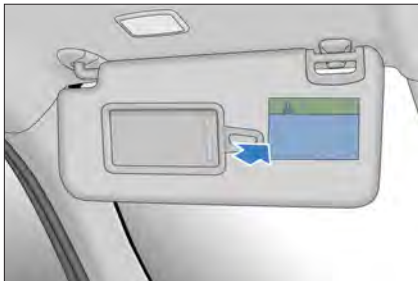

⚠ CAUTION!

- NEVER use a rearward facing child restraint on a seat with an ACTIVE AIRBAG, under risk of SERIOUS INJURY.

Extreme Hazard! Do not use a rearward facing child restraint on a seat protected by an airbag in front of it!

The tire pressure labels are attached below the right B-pillar lock ring.



The child protection lock logo is engraved on the metal sheet surface on the left/right rear door.



The usage tip sticker of the charging connector is attached to the inner surface of the charge port cover.

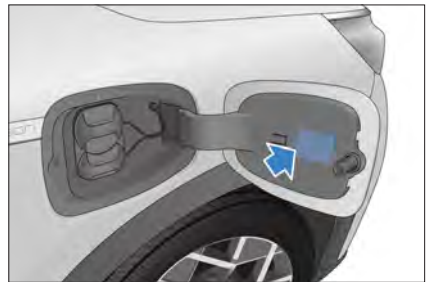

- High voltage label
- (1) Attached to the upper safety cover of powertrain power controller, and small cover of motor rear bracket;
 - (2) Attached to the AC charging line in front cabin;
 - (3) Attached to the distribution line;
 - (4) Attached to top of the front seal cap of battery pack.

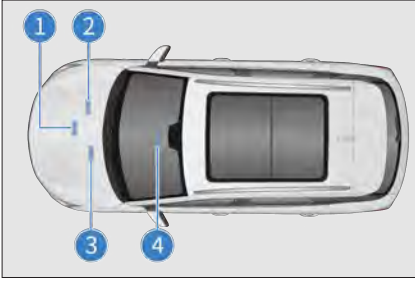

Transponder Mounting Position

The transponder mounting position is located in the upper left of the front windshield.



CAUTION!

- While affixing the electronic labels, do not overlap them with any glass frame or other object.

Numbers

0-100 km/h: Full Throttle Experience	131
12 V Auxiliary Power Outlet.....	148

A

A/C Operation Interface	138
A/C Panel View.....	138
ACC System*	108
Acoustic Vehicle Alerting System (AVAS)	130
Air Conditioning System	169
Air Purification System*	144
Airbag Triggering Conditions and Notes	21
Anti-Theft System.....	31
Automatic Vehicle Hold (AVH)	105

B

Battery Leakage Rescue.....	183
Blind Spot Detection System*	118
Braking System	168
Break-In Period.....	95

C

Carrying Luggage	97
Center Console Cubby	146
Charging Instructions	80
Charging Methods.....	84

Charging Port Electric Lock Control Function	90
Child Protection Lock.....	58
Child Restraint System (CRS)	25
Cooling System	167
Cup Holder	147

D

Data Collection and Processing	32
Discharging Equipment*	88
Door Bins	146
Driver and Front Passenger Airbags	19
Driver Assistance Switch Group.....	73
Driving Key Notes.....	107
Driving Range Display	90
Driving Safety Precautions ...	95
Driving Safety Systems	126
Driving the Vehicle	102

E

Electric Parking Brake (EPB)	103
Electronic Side Mirrors.....	132
Emergency Shutdown System	182
Emergency Warning Light Button.....	74
Energy Regeneration Settings.....	91

F

File Pockets	146
Fire Prevention.....	99
Flood Precautions.....	98
Folding in Rear Seats	61
Front Door Switches	71
Front Seat Adjustment.....	60
Front Seat Side Airbags.....	20
Function Definitions.....	141
Fuses.....	172

G

Gear Shift Controls.....	102
Glove Box.....	146

H

Head Supports	61
Hood	167
How to Save Energy and Prolong Vehicle Service Life	97

I

If Smart Key Battery is Exhausted	182
If the Vehicle Needs Towing	184
In Case of a Flat Tire.....	185
Infotainment Control Panel PAD	151
Instrument Cluster Indicators.....	37

Instrument Cluster View	36
Intelligent Cruise Control System*.....	116
Interior Cleaning	162
Interior Light Switches.....	77
Introduction to Airbags.....	19
Introduction to Keys	48
Introduction to Seat Belts.....	16

L

Lane Keeping System*	115
Language Setting	152
Light Switches.....	65
Locking/Unlocking Door.....	50
Low Voltage Battery (12 V)	94
Luggage Compartment Cover*	150

M

Maintenance Cycle and Contents	154
Mobile Phone Wireless Charging Location	148
Mode Switch Group.....	74

O

Odometer Toggle Switch	73
------------------------------	----

P

PAB Switch*	75
Paint Maintenance Tips	160
Panoramic View System*	122

	Parking Assistance System	123		Transponder Mounting Position.....	196
	Power Battery.....	91			
	Predictive Emergency Braking System	112	U		
R				USB Ports.....	148
	Rear View Mirror	131		Using Seat Belts	16
	Regular Maintenance	159	V		
S				Vehicle Cleaning.....	161
	Safety Handle	147		Vehicle Corrosion Prevention	160
	Seat Information	59		Vehicle Fire Rescue	183
	Self-Maintenance	163		Vehicle Identification	193
	Side Curtain Airbags.....	21		Vehicle Parameters	190
	Smart Access and Start System	57		Vehicle Storage.....	166
	Snow Chains.....	100		Vehicle Travelling Data Recorder*.....	134
	Starting the Vehicle.....	101		Vents	143
	Suggestions for Vehicle Use	96	W		
	Sun Visors	147		Warning Labels.....	194
	Sunroof Maintenance.....	165		When the Battery Runs Out	187
	Sunroof Switch.....	76		When the Vehicle Needs Supporting	188
	Switching on A/C with Cloud Service APP	145		Widgets	152
T				Window Control Switch on Passenger Side	73
	Tire Pressure Monitoring	120		Windshield Washer	168
	Tires	170		Wiper Blades	169
	Towing Practices	95		Wiper Switches.....	69
	Traffic Sign Recognition System	114		Wipers.....	133

Abbreviations List

Abbreviations

Abbreviations	Full Name	Abbreviations	Full Name
ECU	Electronic Control Unit	ABS	Anti-lock Braking System
AUTO	Automatic	ACC	Adaptive Cruise Control
USB	Universal Serial Bus	ECO	Economic
NORMAL	Normal	SPORT	Sport
SOC	State of Charge	AVH	Automatic Vehicle Hold
EPB	Electric Parking Brake	PCW	Predictive Collision Warning
AEB	Autonomous Emergency Braking	BSD	Blind Spot Detection System
RCTA	Rear Cross Traffic Alert	DOW	Door Open Warning
TPMS	Tire Pressure Monitoring System	VDC	Vehicle Dynamic Control
TCS	Traction Control System	HHC	Hill-start Hold Control
HBA	Hydraulic Break Assist	CDP	Controller Deceleration Parking
HDC	Hill Descent Control	PM2.5	Air Purification System
MAX	Maximum	MIN	Minimum
VIN	Vehicle Identification Number		